

Report to Planning Committee

15 February 2022

Application Reference	DC/21/66125
Application Received	16 th September 2021
Application Description	Proposed industrial/warehousing development (use classes B2/ B8) together with associated access, servicing, parking and landscaping.
Application Address	Newcomen Drive Open Space Newcomen Drive Tipton
Applicant	Mr J Kelly
Ward	Tipton Green
Contact Officer	William Stevens William_stevens@sandwell.gov.uk

1 Recommendations

1.1 Subject to the application being heard at Full Council, and no objections from Highways, Pollution Control (Noise), and The Wildlife Trust for Birmingham and the Black Country, that planning permission is granted subject to conditions relating to:

- (i) External materials as per submission;
- (ii) Hard and soft landscaping;
- (iii) Finished floor levels;
- (iv) Boundary treatment (including any retaining walls);
- (v) Electric vehicle charging points;



- (vi) Construction management plan (including dust management, hours of construction, wheel cleaning etc as well as additional requirements of the Canal and River Trust);
- (vii) Travel plan implementation;
- (viii) Low NOx boilers;
- (ix) Ground contamination and gas monitoring with mitigation measures;
- (x) Coal mining investigation and mitigation measures;
- (xi) Risk assessment and method statement (Canal and River Trust);
- (xii) Drainage and SuDS;
- (xiii) CCTV;
- (xiv) Details of proposed external lighting;
- (xv) Desk top based archaeological survey;
- (xvi) Ecological survey and mitigation measures; and
- (xvii) 10% renewable energy provision.

2 Reasons for Recommendations

- 2.1 The proposal brings forward a site that has remained undeveloped for a good number of years and which has been used for fly tipping in the past. The proposal would create jobs and bring investment into the local area.

3 How does this deliver objectives of the Corporate Plan?

	A strong and inclusive economy
---	--------------------------------

4 Context

- 4.1 This application is being reported to your Planning Committee because the proposed use is a departure from the Council's Local Plan and objections have also been received.
- 4.2 To assist members with site context, links to several Google Map images are provided below:



[Aerial View](#)

[Street View](#)

[View from Newcomen Drive](#)

5 Key Considerations

- 5.1 The site is allocated for housing and if members were to approve the application, it would have to go to Full Council for ratification.
- 5.2 The material planning considerations which are relevant to this application are: -

Government policy (NPPF)

Proposals in the Development Plan

Planning history (including appeal decisions)

Loss of light and/or outlook

Overshadowing

Public visual amenity

Overbearing nature of proposal

Traffic generation

Contamination by a previous use

Noise and disturbance from the scheme

Nature conservation and loss of ecological habitats

Loss of trees

Flood risk

6. The Application Site

- 6.1 The application site is an area of green space sandwiched between industrial units to the west and residential properties to the east. Access to the site would remain as it is now, through Coneygree Road.



7. Planning History

7.1 The site has a history of applications being approved; from residential uses to industrial purposes. However, the land has been vacant for a significant period with no development taking place on the site.

7.2 The relevant planning applications are as follows:

DA/18345	Infilling of site to plans R/C/BQ/1 & 2.	Grant permission subject to conditions 14/02/1985
BCS0315	Residential development, landscaping and woodland planting and relocated and improved football pitch and clubroom.	Grant Outline Permission with Conditions 07/10/1988
BCS0585	Residential development, landscaping and woodland planting; relocated and improved football pitch and clubroom.	Grant Conditional Reserved Matters 19/06/1989
BCS0827	General industrial and associated open storage/car parking.	Non-Determination 25/11/1992
BCS0828	General industrial and associated open storage/car parking.	Non-Determination 25/11/1992



BCS3553	Recycling and waste transfer station	Withdrawn 23/03/1998
DC/08/49278	Demolition of industrial units to enable vehicular access into the site, regrading of the site and stabilisation of the old mine workings, residential development of up to 300 dwellings comprising access alterations onto Coneygre Road and Burnt Tree Road and erection of a landscaped acoustic bund (outline application).	Appeal Allowed 23/04/2009
DC/12/54472	Renewal of extant planning permission DC/08/49278: Demolition of industrial units to enable vehicular access into the site, re-grading of the site and stabilisation of the old mine workings, residential development of up to 300 dwellings comprising access alterations onto Coneygre Road and Burnt Tree Road and erection of a landscaped acoustic bund (outline application).	Not determined
DC/21/65676	Screening opinion for proposed industrial and	EIA not required 26/05/2021



	warehouse units with associated access and works.	
--	---	--

7.3 The Council has also dealt with two enforcement cases on the site regarding issues with the boundary wall and untidy land (GS/13/9065 and GS/19/10965 respectively). Whilst those issues have been addressed, a further complaint; case GS/21/11567 has recently been received for untidy land.

8. Application Details

8.1 The applicant proposes to create a new service road from the existing industrial estate, creating five new industrial/warehousing units, (use classes B2/ B8) together with associated access, servicing, parking and landscaping.

8.2 Units 1 and 2 (nearest to the residential units in Newcomen Drive at 47m) would be 11m high, whereas Unit 5 would stand at 15.6m high and be over 90m from the nearest property in Lindley Avenue.

8.3 Access to and operation of the units would be 24/7. In total 270 parking spaces will be available and space for 27 cycles.

9. Publicity

9.1 The application has been publicised by 71 neighbour notification letters, site notice and press notice. A total of eight objections have been received along with a 155-signature petition against the proposal.

9.2 Objections

Objections have been received on the following grounds:



- i) Concerns over noise given the proximity of the development to residential units, combined with the new metro line bordering the site;
- ii) The proposal is allocated for residential use and not industrial;
- iii) Light pollution from the proposed development would disturb residents' sleep during the night;
- iv) The development would increase traffic in the local area;
- v) The development would increase pollution in the area;
- vi) Concerns over potential poisonous gases on site given the use was a former tar pit;
- vii) The proposed development will impact on the local environment, forcing existing wildlife to move from the site whilst the site is treated and developed and further removal of greenery in Tipton;
- viii) Not all residents in the area have been notified of the application;
- ix) The introduction of a walkway from Newcomen Drive may introduce security issues to local residents and increase anti-social behaviour and criminal offences; and
- x) The proposed development will potentially increase flooding in the area.

Immaterial objections have been raised including promises from developers (of Newcomen Drive housing estate) that nothing will be built on this land when the residents brought the houses on Newcomen Drive, and that the development will impact on the resale value of residential properties.

9.3 Responses to objections

I respond to the objector's comments in turn:

- (i) Public Health comments awaited. Members will be verbally updated.
- (ii) The site is allocated for residential use. Despite this, the site remains undeveloped with no indication that the land will come forward for residential use. Given the on-going complaints received



over the condition of the site (point 7.4) the scheme would provide jobs and investment into the area.

- (iii) The proposed development is a significant distance away from residential properties and bound by mature vegetation. Whilst it is extremely unlikely that residents would be disturbed by light pollution, a condition can be attached to any approval ensuring details of a lighting scheme.
- (iv) Comments from the Council's Highways department will be verbally reported.
- (v) The Council's Public Health Team has raised no objections and suggested conditions such as vehicle charging points to lessen any impact.
- (vi) Before any development takes place, a detailed site investigation would need to occur, and mitigation measures agreed to ensure the users of the site and local residents remain safe.
- (vii) The existing vegetation on the boundary of the site would remain and additional planting provided. However, it is important that during the construction phase, wildlife disturbance is kept to a minimum. Therefore, further comments from the wildlife trust are pending.
- (viii) 71 individual addresses were sent a letter, as well as site notices posted, and the application publicised in the local newspaper.
- (ix) No walkway is proposed and in between the development and the landscaping border with Newcomen Drive will be a 4.0m high acoustic fence providing additional security and screening.
- (x) Issues over drainage and sustainable drainage systems can be addressed via condition.

10. Consultee responses

10.1 Planning and Transportation Policy

The site of the proposed development is allocated for housing; therefore, the proposed industrial development would be a departure from the local plan allocation. Under Black Country Core Strategy (BCCS) policies DEL2, EMP1 and EMP4 (see 12.1).



According to policy EMP4 of the BCCS, the Council should have a supply of 70 hectares of readily available employment land, the Council has a short fall, and the proposed development would go some way help fill this gap.

Taking the above into account there are no policy issues with the proposed industrial/warehouse development of the site, and no objections to the departure.

10.2 Highways

Further information has been requested and members will be verbally updated.

10.3 Public Health (Air Quality)

No objections have been received and it is recommended that conditions are attached to any approval that include electric vehicle charging points, a dust management plan (part of the construction management plan) to protect local residents during the construction phase of the development, as well as the implementation of the submitted travel plan, and the installation of Low NOx Boilers.

10.4 Public Health (Contaminated Land)

Contamination reports have been submitted as part of the application which conclude that a watching brief is required by a competent person and if contaminates are found, these are reported to Public Health along with the proposed mitigation measures. Further gas monitoring is also required on site and can be conditioned accordingly.

10.5 Public Heath (Air Pollution and Noise)

Members will be verbally updated.



10.6 Urban Design

No objection to the proposal.

10.7 West Midlands Police

No objections have been received, however recommend conditions that cover security measures like CCTV and external lighting.

10.8 Network Rail

No objection.

10.9 Lead Local Flood Authority

Additional information has been requested and sent to the Lead Local Flood Authority. This can be covered by the standard drainage and sustainable drainage system conditions.

10.10 Severn Trent

No objections subject to their standard conditions being attached to any approval.

10.11 The Coal Authority

Additional information has been received and the Coal Authority raises no objection subject to suitable site investigation and remediation measures.

10.12 The Canal and River Trust

Raise no objections to the development but wish to protect their asset. Therefore, have requested a condition regarding a risk assessment and method statement being submit to and approved that would include vibration monitoring. Other conditions include, landscaping, drainage,



contamination, unexpected contamination, construction management plan, details of external lighting, archaeology, and an informative placed on any approval with contact details of who the developer should contact from the trust. The majority of the above can be incorporated into the Council's standard conditions.

10.13 The Wildlife Trust for Birmingham and the Black Country

Currently objects, and additional information has been submitted. Further investigations are required, however due to the time of the year, and various issues on the site, i.e. Japanese knotweed, the applicant has requested this is controlled by condition. A request was made to the trust without response. Whilst an ecological survey is conditioned, members will be verbally updated on any response received.

11. National Planning Policy

11.1 National Planning Policy Framework promotes sustainable development but states that local circumstances should be taken into account to reflect the character, needs and opportunities for each area.

12. Local Planning Policy

12.1 The following polices of the council's Development Plan are relevant:

ENV3: Design Quality

ENV5: Flood Risk, Sustainable Drainage System and Urban Heat Island Effect

ENV7: Renewable Energy

ENV8: Air Quality

TRAN2: Managing Transport Impacts of New Development

DEL2: Managing the Balance between Employment Land and Housing

EMP1: Providing for Economic Growth and Jobs

EMP4: Canals

SAD H1: Housing Allocations

SAD EOS9: Urban Design Principles



SAD EOS10: Design Quality and Environmental Standards

- 12.2 The site of the proposed development is allocated for residential use, therefore SAD policy H1 is applicable. However, no residential uses are proposed, and the development is classed as a departure from the Local Plan (refer to viability issues below).
- 12.3 BCCS Policy DEL2 states that proposals for new employment development in areas of housing growth will be resisted where it is not consistent with housing led regeneration of the area. It has been ten years since the adoption of the BCCS and the site remains undeveloped for housing and is unlikely to come forward due to viability issues.
- 12.4 BCCS Policy EMP1 aims to provide land for at least 75,000 industrial and warehouse jobs in the Black Country by 2026. For this, there needs to be a ready supply of available land at any one time. Under BCCS Policy EMP4, Sandwell should have 70ha of available employment land available at any one time (the Council currently has 23ha). The borough has been well under this level of provision since the adoption of the BCCS in 2011, therefore the proposed industrial development of the site would be welcome as this would bring forward new industrial development that would add to the existing stock of employment land.
- 12.5 Under SAD policy EOS10 the design of industrial developments should be of a high standard and should consider the design principles set out in SAD policy EOS9 and will be required to pay particular attention to materials and landscaping, pollution and noise control, environmental impact on the site and surrounding area, including wildlife habitats.
- 12.6 Part of the site forms part of a wider wildlife corridor, therefore BCCS policy ENV1 is applicable, guidance set out this this policy states that the movement of wildlife within the Black Country through linear habitat such as wildlife corridors are not impeded by development. When a full planning application is submitted adequate information must be submitted setting out proposed mitigation measures, so that the movement of wildlife through the site is not adversely affected by the development.



- 12.7 Another part of the site is bordered by the Birmingham Canal, therefore BCCS policy ENV4 is applicable, under this policy all development proposals likely to affect the canal network; must protect and enhance its nature conservation value, protect its visual amenity.
- 12.8 The proposed development will have to give regard to both BCCS policy ENV5 relating to the incorporation of sustainable drainage systems to assist with reducing the impact of flooding and surface water run-off.
- 12.9 As the development will be for over 1,000 sqm of new industrial space, BCCS policy ENV7 will be applicable. The guidance under this policy states all industrial developments of 1,000 sqm or more must incorporate the generation of energy from renewable sources sufficient to off-set at least 10% of the estimated residual energy demand.
- 12.10 The proposed development would have to give regard to the guidance contained in BCCS policy ENV8 and the Air Quality SPD.

13. Material Considerations

13.1 National and local planning policy considerations have been referred to above in sections 11 and 12. With regards to the other material considerations, these are highlighted below:

13.2 Proposals in the Development Plan

The proposal is contrary to the Council's Development Plan; however, the site has remained vacant for such a long time, and raises viability issues, that residential development is unlikely to come forward. The proposed development would create jobs in the local area and regenerate the site.



13.3 Planning history

The site has significant planning history and recent enforcement complaints over the untidy condition of the site. This new development should address these issues.

13.4 Loss of light and/or outlook

It is not anticipated that the proposed development would cause any significant loss of light and/or outlook issues to the occupiers of nearby residents given the separation distances and the mature vegetation on the boundary.

13.5 Overshadowing

For the reasons mentioned in 13.4 above, I do not foresee any overshadowing of residential properties.

13.6 Public visual amenity

Given the mature vegetation, the development is unlikely to be seen from nearby residential properties.

13.7 Overbearing nature of proposal

See points 13.4-13.6 above.

13.8 Traffic generation

The Council's Highways team has requested additional information and members will be updated accordingly.

13.10 Contamination by a previous use

The combination of the existing contamination of the land and mine shafts is one of the barriers why this site has never been developed



previously. However, the applicant is preparing to clean up the site and bring it back into use.

13.11 Noise and disturbance from the scheme

The Council's Public Health officers have raised no objections.

13.12 Nature conservation and loss of ecological habitats

See points 10.13 and 13.13.

13.13 Loss of trees

The existing vegetation on the boundary of the site is to remain with additional planting to increase the overall landscaping of the site.

13.14 Flood risk

This can be controlled via condition to prevent any localised flooding.

14 Alternative Options

14.1 Refusal of the application is an option if there are material planning reasons for doing so, however the site has been undeveloped for a significant amount of time, and Council resources impacted on by managing fly tipping on the site.

15 Implications

Resources:	When a planning application is refused the applicant has a right of appeal to the Planning Inspectorate, and they can make a claim for costs against the Council.
Legal and Governance:	This application is submitted under the Town and Country Planning Act 1990.
Risk:	None.



Equality:	There are no equality issues arising from this proposal and therefore an equality impact assessment has not been carried out.
Health and Wellbeing:	None
Social Value	The proposal would potential provide jobs for the local area as well as apprenticeships during the construction phase.

16. Appendices

Site Plan

Context Plan

19-103-PA-01 A

19-103-PA-02 A

19-103-PA-03 A

19-103-PA-04 A

19-103-PA-05 A

19-103-PA-06 A

19-103-PA-07 A

19-103-PA-08 A

19-103-PA-09 A

19-103-PA-10 A

19-103-PA-11 A

19-103-PA-03 - 1



DC/21/66125
Newcomen Drive Open Space, Tipton

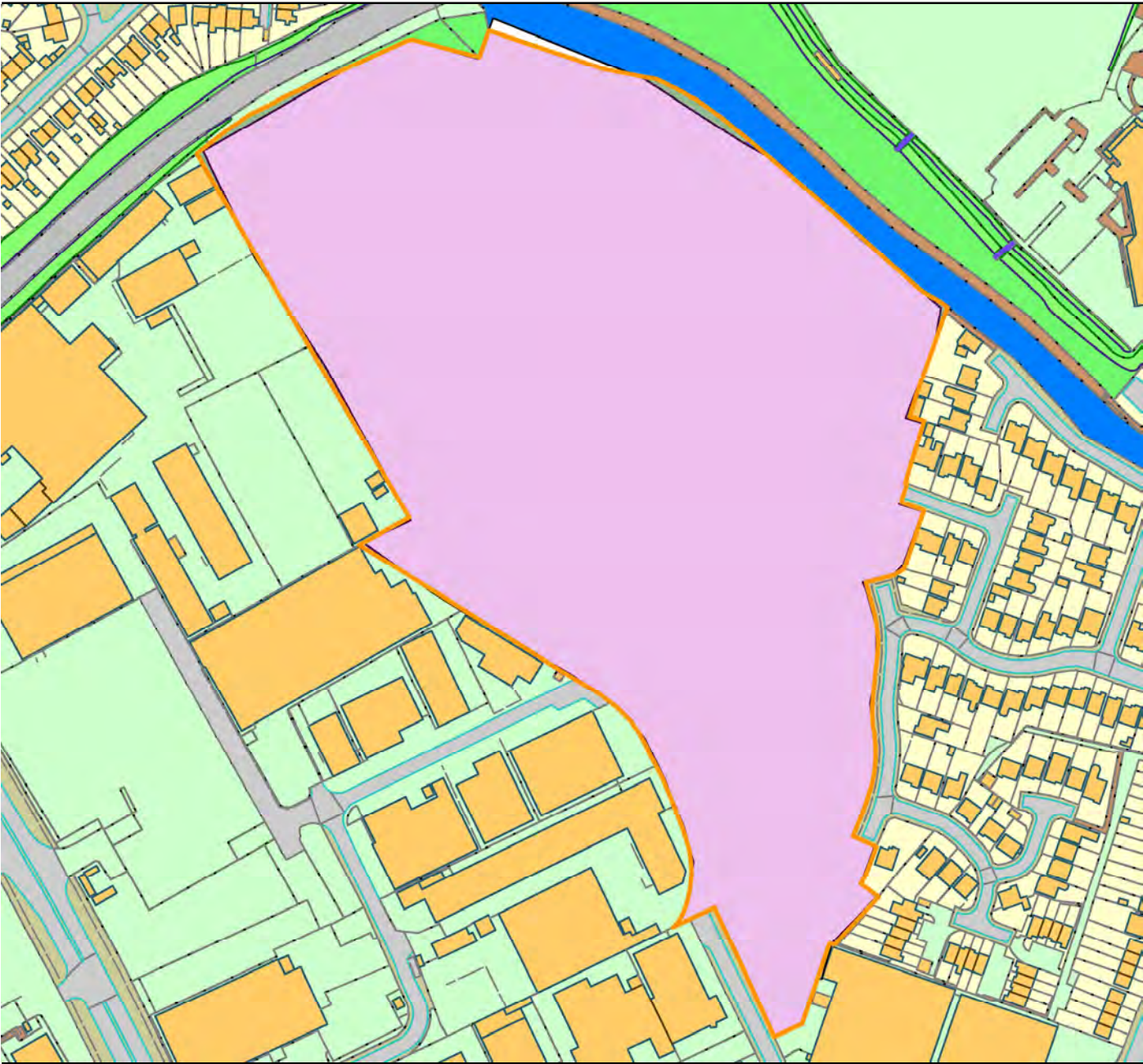

Legend

Sc 1:2781

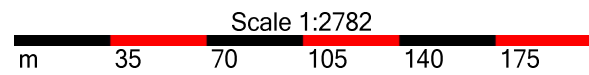

© Crown copyright and database rights 2019
Ordnance Survey Licence No 100023119

Organisation	Not Set
Department	Not Set
Comments	Not Set
Date	04 January 2022
OS Licence No	

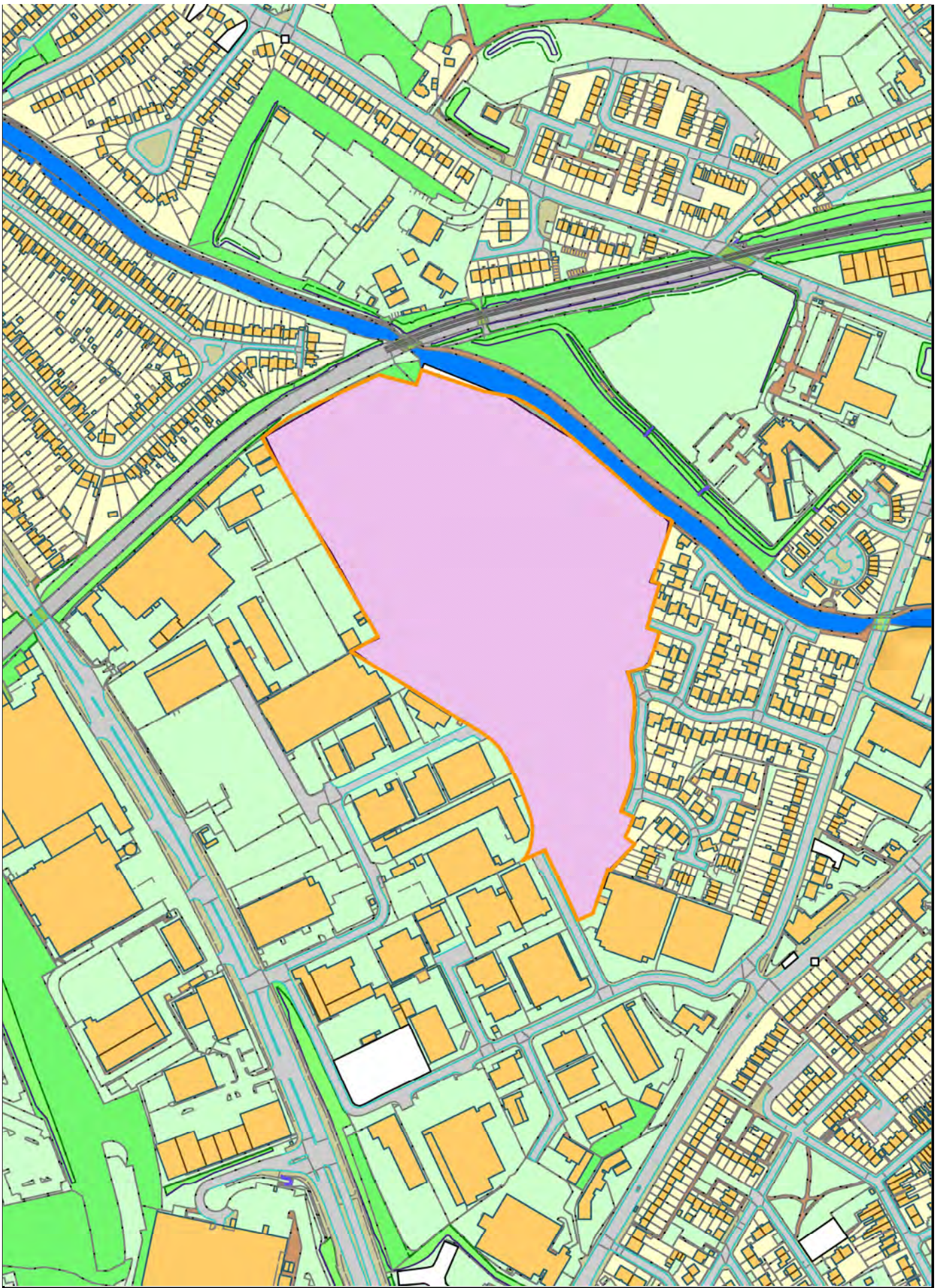

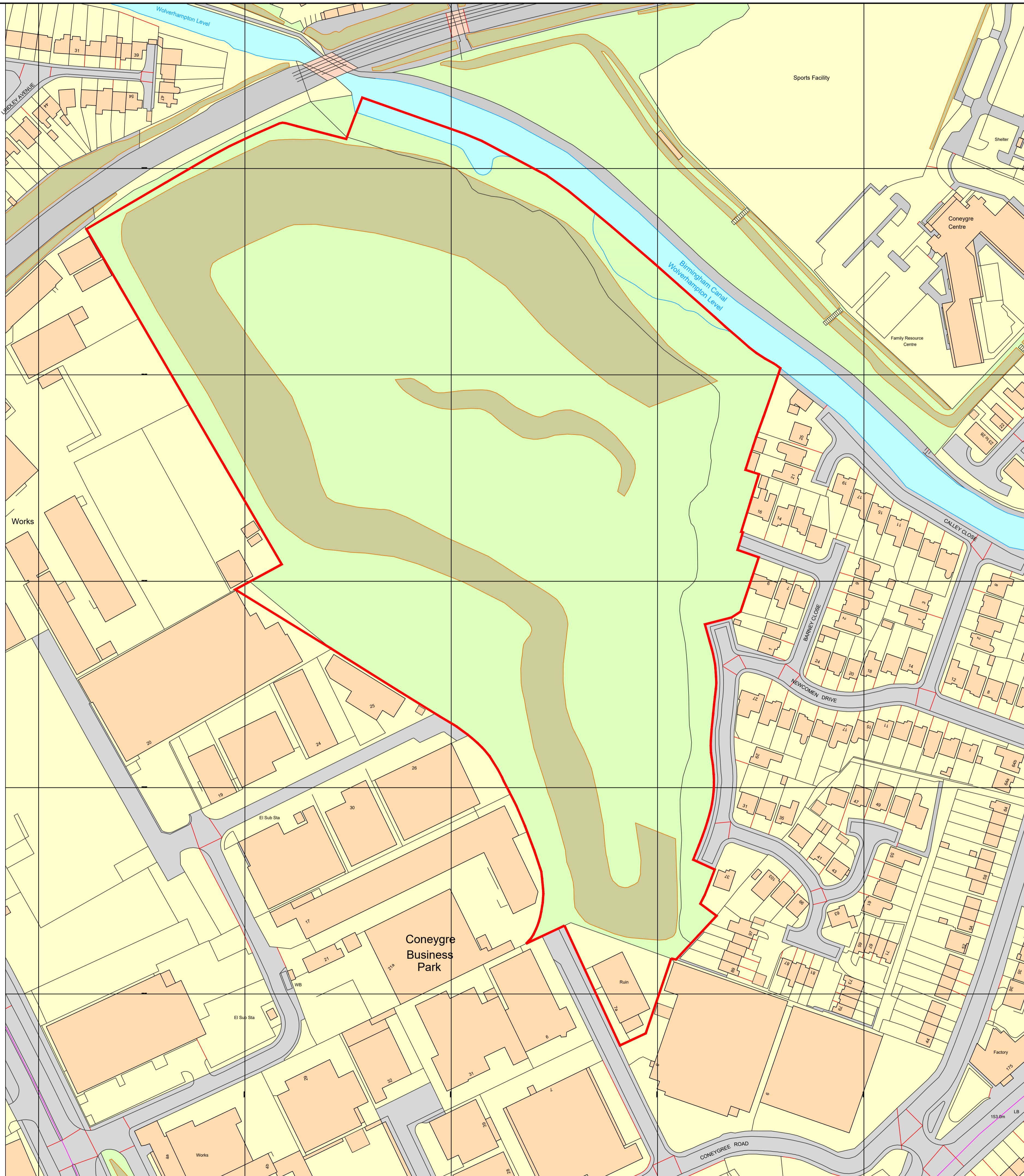

© This drawing and the building works depicted are the copyright of BHP Design LLP and may not be reproduced or amended except by written permission. No liability will be accepted for amendments made by other persons.

The Contractor is to check and verify all building and site dimensions, levels and sewer invert levels at connection points before work starts. The Contractor is to comply in all respects with current Building Legislation, Party Wall Act, etc. whether or not specifically stated on this drawing. This drawing must be read with and checked against any structural, geotechnical or other specialist documentation provided.

This drawing is not intended to show details of foundations, ground conditions or ground contaminants. Each area of ground relied upon to support any structure depicted (including drainage) must be investigated by the Contractor. A suitable method of foundation should be provided, allowing for existing ground conditions. Any suspect or fluid ground, contaminants on or within the ground, should be further investigated by a suitable expert. Any earthwork constructions shown indicate typical slopes for guidance only & should be further investigated by a suitable expert.

Where existing trees are to be retained they should be subject to a full Arboricultural Inspection for safety. All trees are to be planted so as to ensure they are a minimum of 5 metres from buildings and 3 metres from drainage and services. A suitable method of foundation is to be provided to accommodate the proposed tree planting.

Sketch proposals are for illustrative purposes only & as such are subject to detailed site investigation including ground conditions/contaminants, drainage, design & planning/density negotiations. Sketch proposals may be based upon enlargements of OS sheets & visual estimations of existing site features, accuracy will therefore need to be verified by survey. Sketch proposals have not been considered in respect of CDM Regulations.

Rev	Date	Note
A	23/09/21	Updated to suit LPA comments

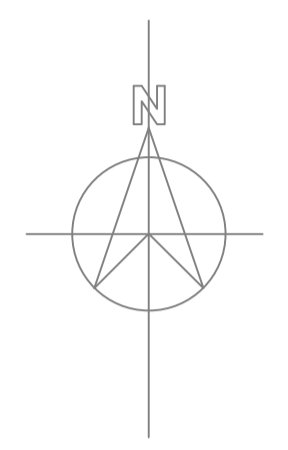

PLANNING

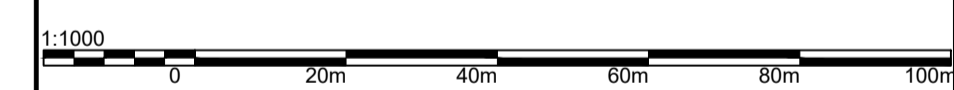

bhpdesign

St. Paul's Place, 40 St. Paul's Square, Birmingham, B3 1FQ, United Kingdom
 t. +44(0)121 314 6618 e : info@bhp-design.co.uk

CLIENT: CONEYGRE REDEVELOPMENTS LTD

PROJECT: LAND OFF CONEYGRE ROAD TIPTON

TITLE: SITE PLAN - AS EXISTING (OS BASED)

Scale: 1:1000 @ A1	Date: AUG 2021
Design: DFC	Draft: JC
Drg No: 19-103-PA-02	Revision: A



SCHEDULE OF MATERIALS (EXTERNAL WORKS - SEE UNIT 1 FOR TYPICAL MATERIALS TO BE USED SITE WIDE)

- MACADAM SURFACING
- THERMOPLASTIC PAINT LINING ETC.
- COLOUR - BLACK/GREY SELF COLOUR WITH LINING TO CONVENTION
- CONCRETE BLOCK PAVING
- REGULAR TYPE PAVING
- COLOUR - TBA
- CONCRETE SURFACING
- COLOUR - LIGHT GREY SELF COLOUR
- GENERALLY 2.4M HIGH PALADIN FENCE
- SURFACE COATED IN PROPRIETARY FINISH
- COLOUR - TBA
- FABRICATED STEEL PEDESTRIAN/VEHICULAR GATES/CONTROL BARRIER
- FULL SPECIFICATION PAINT FINISH
- COLOUR - TBA (REFER TO DRAWING REF-PA-11 FOR FURTHER DETAILS)
- STRUCTURED LANDSCAPING
- SCHEME TO BE APPROVED BY LOCAL AUTHORITY
- PRIOR TO IMPLEMENTATION

This drawing and the building works depicted are the copyright of BHP Design LLP and may not be reproduced or amended except by written permission. No liability will be accepted for amendments made by other persons.

The Contractor is to check and verify all building and site dimensions, levels and sewer invert levels at connection points before work starts. The Contractor is to comply in all respects with current Building Regulations, British Standard Specifications, Building Regulations, Construction (Design & Management) Regulations, Party Wall Act, etc. whether or not specifically stated on this drawing. This drawing must be read with and checked against any structural, geotechnical or other specialist documentation provided.

This drawing is not intended to show details of foundations, ground conditions or ground contaminants. Each area of ground relied upon to support any structure depicted (including drainage) must be investigated by the Contractor. A suitable method of foundation should be provided, allowing for existing ground conditions. Any suspect or fluid ground, contaminants on or within the ground, should be further investigated by a suitable expert. Any earthwork constructions shown indicate typical slopes for guidance only & should be further investigated by a suitable expert.

Where existing trees are to be retained they should be subject to a full Arboricultural Inspection for safety. All trees are to be planted so as to ensure they are a minimum of 5 metres from buildings and 3 metres from drainage and services. A suitable method of foundation is to be provided to accommodate the proposed tree planting.

Sketch proposals are for illustrative purposes only & as such are subject to detailed site investigation including ground conditions/contaminants, drainage, design & planning/density negotiations. Sketch proposals may be based upon enlargements of OS sheets & visual estimations of existing site features, accuracy will therefore need to be verified by survey. Sketch proposals have not been considered in respect of CDM Regulations.

Notes:

Rev	Date	Note
A	23/09/21	Updated to suit LPA comments

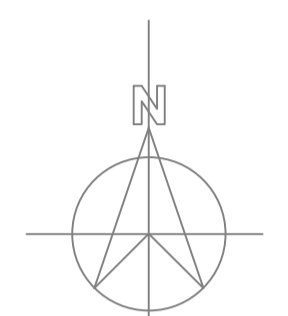

SCHEDULE OF ACCOMMODATION:

UNIT 1:	20,000 SQ.FT (INC 10% 2 STOREY OFFICE)
UNIT 2:	30,000 SQ.FT (INC 10% 2 STOREY OFFICE)
UNIT 3:	40,000 SQ.FT (INC 10% 2 STOREY OFFICE)
UNIT 4:	60,000 SQ.FT (INC 10% 2 STOREY OFFICE)
UNIT 5:	80,000 SQ.FT (INC 10% 2 STOREY OFFICE)
TOTAL:	230,000 SQ.FT

PLANNING

Revisions: Amendment: Date: Name:



bhpdesign

St. Paul's Place, 40 St. Paul's Square, Birmingham, B3 1FQ, United Kingdom
t. +44(0)121 314 6618 e : info@bhp-design.co.uk

CLIENT: CONEYGREE REDEVELOPMENTS LTD

PROJECT: LAND OFF CONEYGREE ROAD TIPTON

TITLE: SITE PLAN - AS PROPOSED (OS BASED)

Scale:	1:1000 @ A1	Date:	AUG 2021
Design:	DFC	Draft:	JC
Drg No:	19-103-PA-03	Revision:	A

© This drawing and the building works depicted are the copyright of BHP Design LLP and may not be reproduced or amended except by written permission. No liability will be accepted for amendments made by other persons.

The Contractor is to check and verify all building and site dimensions, levels and sewer invert levels at connection points before work starts. The Contractor is to comply in all respects with current Building Legislation, British Standard Specifications, Building Regulations, Construction (Design & Management) Regulations, Party Wall Act, etc. whether or not specifically stated on this drawing. This drawing must be read with and checked against any structural, geotechnical or other specialist documentation provided.

This drawing is not intended to show details of foundations, ground conditions or ground contaminants. Each area of ground relied upon to support any structure depicted (including drainage) must be investigated by the Contractor. A suitable method of foundation should be provided, allowing for existing ground conditions. Any suspect or fluid ground, contaminants on or within the ground, should be further investigated by a suitable expert. Any earthwork constructions shown indicate typical slopes for guidance only & should be further investigated by a suitable expert.

Where existing trees are to be retained they should be subject to a full Arboricultural Inspection for safety. All trees are to be planted so as to ensure they are a minimum of 5 metres from buildings and 3 metres from drainage and services. A suitable method of foundation is to be provided to accommodate the proposed tree planting.

Sketch proposals are for illustrative purposes only & as such are subject to detailed site investigation including ground conditions/contaminants, drainage, design & planning/conservation negotiations. Sketch proposals may be based upon enlargements of OS sheets & visual estimations of existing site features, accuracy will therefore need to be verified by survey. Sketch proposals have not been considered in respect of CDM Regulations.

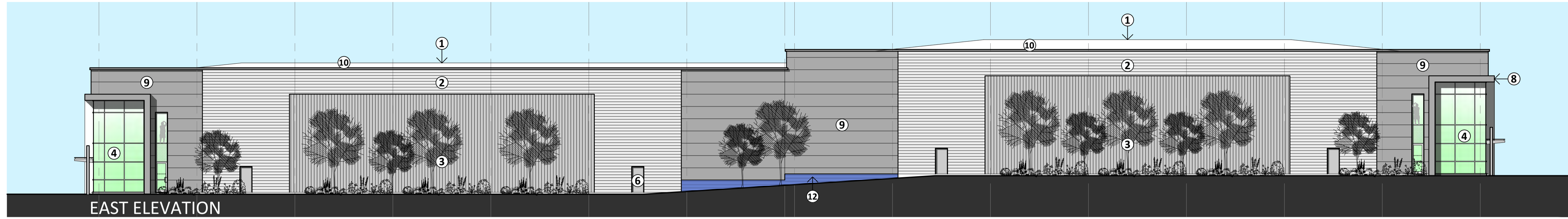

EAST ELEVATION

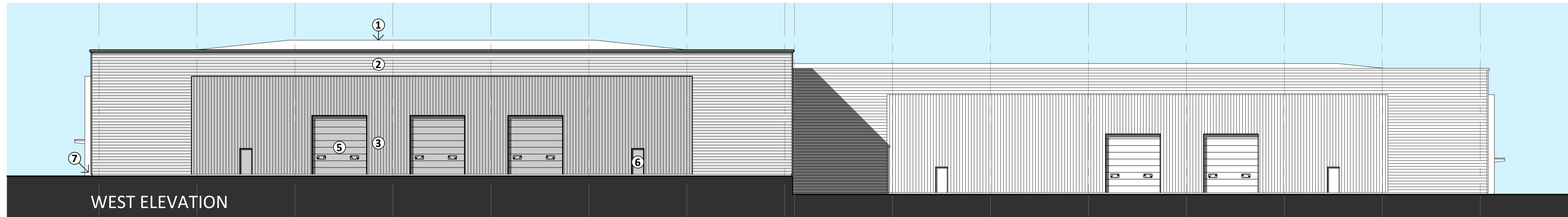

WEST ELEVATION



NORTH ELEVATION

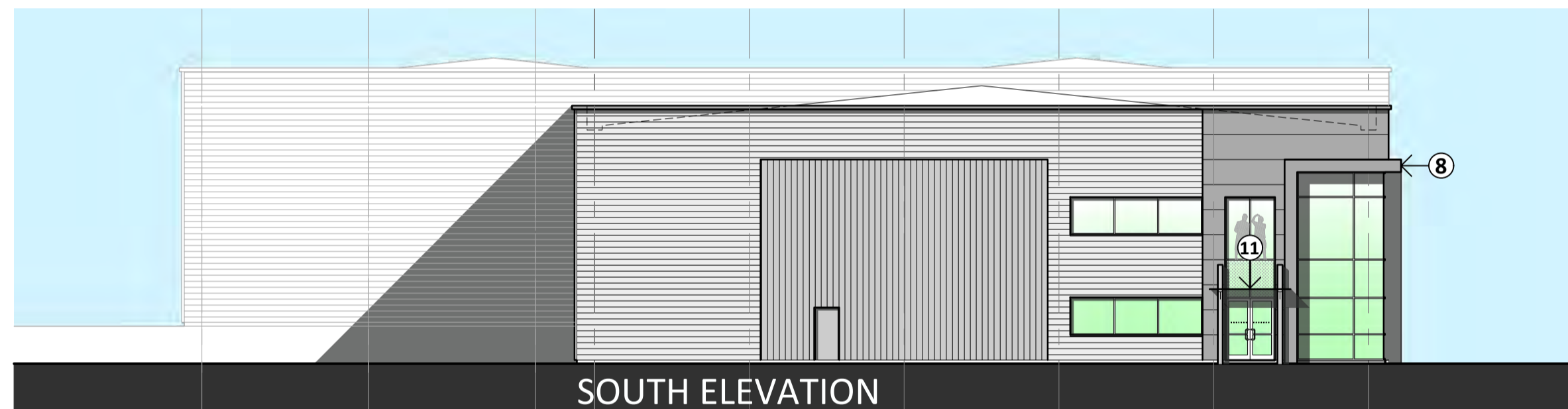

SOUTH ELEVATION

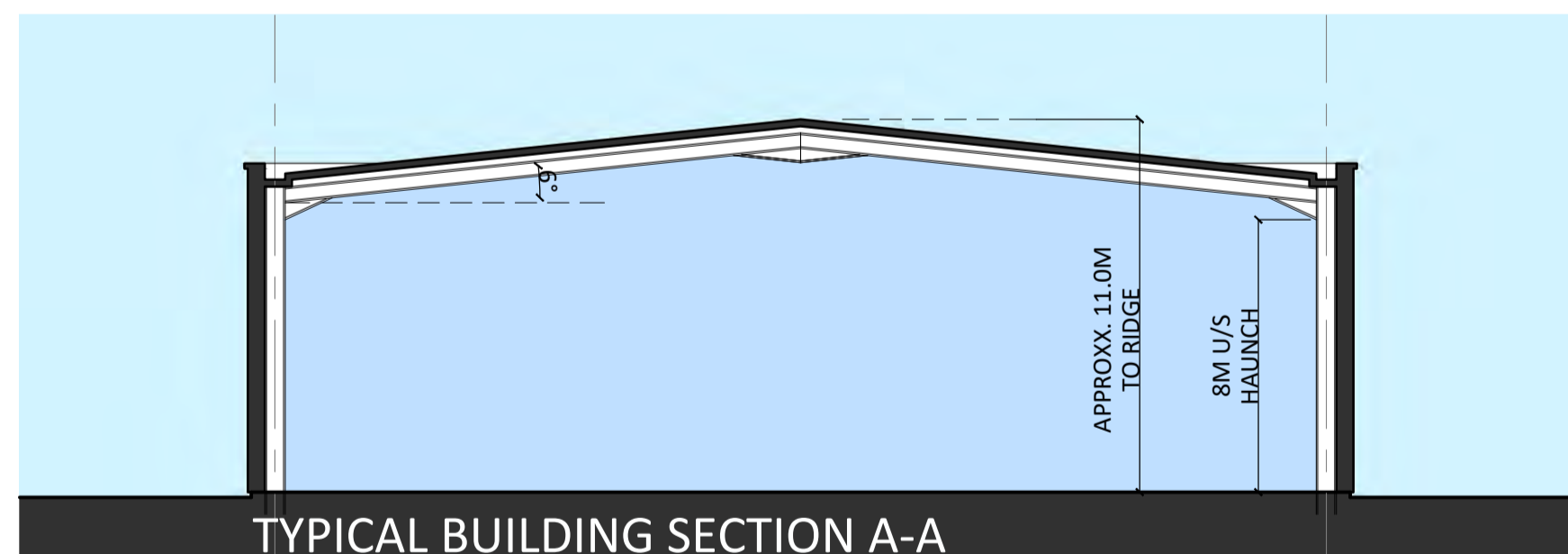

TYPICAL BUILDING SECTION A-A

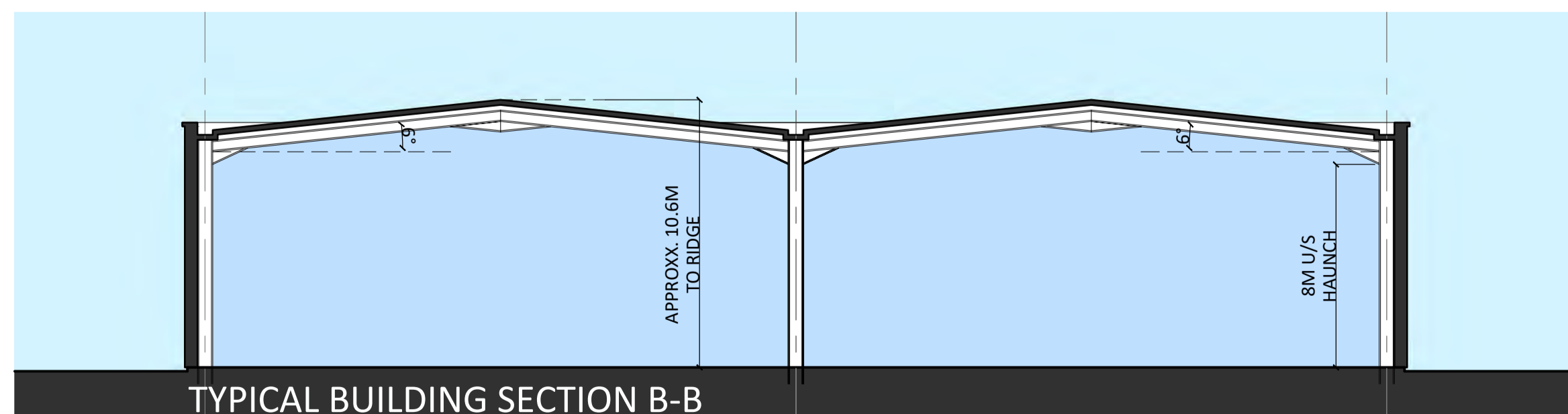

TYPICAL BUILDING SECTION B-B

SCHEDULE OF BUILDING MATERIALS:

- ① KINGSPAN KS1000 RW TRAPEZOIDAL PROFILE INSULATED ROOF PANELS OR SIMILAR APPROVED. COLOUR GOOSEWING GREY
- ② HALF ROUND PROFILE WALL CLADDING. COLOUR METALLIC SILVER (RAL 9006)
- ③ METAL PROFILED WALL CLADDING. COLOUR BASALT GREY (RAL 7012)
- ④ ALUMINIUM THERMALLY BROKEN CLEAR DOUBLE GLAZED DOORS & WINDOWS. COLOUR RAL 7016
- ⑤ SECTIONAL DOORS. RAL 7016
- ⑥ POWDERCOATED STEEL DOORS. COLOUR RAL 7016
- ⑦ GALVANISED PFC GROUND BEAM. COLOUR - TBC
- ⑧ METTALINE FEATURE BEAM PROFILED EDGE TRIM. COLOUR ANTHRACITE (RAL 7016)
- ⑨ MICRO RIB CLADDING HORIZONTALLY LAID. COLOUR ANTHRACITE (RAL 7016)
- ⑩ ROOFLIGHTS (10%) - NATURAL DAYLIGHT TO REACH CORNERS OF UNIT.
- ⑪ STEEL FABRICATED ENTRANCE CANOPY WITH PLANAR GLASS ROOF FULL SPECIFICATION PAINT FINISH. COLOUR: WHITE
- ⑫ ENGINEERING BRICKWORK TO FORM BUILDING RETENTION. COLOUR BLUE

Rev	Date	Note
A	23/09/21	Updated to suit LPA comments

PLANNING

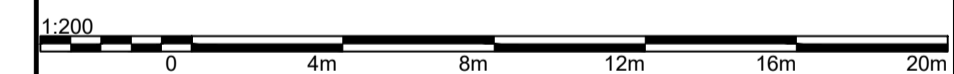

bhpdesign
 St. Paul's Place, 40 St. Paul's Square, Birmingham, B3 1FQ, United Kingdom
 t. +44(0)121 314 6618 e : info@bhp-design.co.uk

CLIENT: CONEYGRE REDEVELOPMENTS LTD
 PROJECT: LAND OFF CONEYGRE ROAD TIPTON
 TITLE: UNIT 1 & 2 ELEVATIONS & SECTION - AS PROPOSED

Scale: 1:200 @ A1	Date: AUG 2021
Design: -	Draft: SL
Drg No: 19-103-PA-07	Revision: A

© This drawing and the building works depicted are the copyright of BHP Design LLP and may not be reproduced or amended except by written permission. No liability will be accepted for amendments made by other persons.

The Contractor is to check and verify all building and site dimensions, levels and sewer invert levels at connection points before work starts. The Contractor is to comply in all respects with current Building Regulations, British Standard Specifications, Building Regulations, Construction (Design & Management) Regulations, Party Wall Act, etc. whether or not specifically stated on this drawing. This drawing must be read with and checked against any structural, geotechnical or other specialist documentation provided.

This drawing is not intended to show details of foundations, ground conditions or ground contaminants. Each area of ground relied upon to support any structure depicted (including drainage) must be investigated by the Contractor. A suitable method of foundation should be provided, allowing for existing ground conditions. Any suspect or fluid ground, contaminants on or within the ground, should be further investigated by a suitable expert. Any earthwork constructions shown indicate typical slopes for guidance only & should be further investigated by a suitable expert.

Where existing trees are to be retained they should be subject to a full Arboricultural Inspection for safety. All trees are to be planted so as to ensure they are a minimum of 5 metres from buildings and 3 metres from drainage and services. A suitable method of foundation is to be provided to accommodate the proposed tree planting.

Sketch proposals are for illustrative purposes only & as such are subject to detailed site investigation including ground conditions/contaminants, drainage, design & planning/density negotiations. Sketch proposals may be based upon enlargements of OS sheets & visual estimations of existing site features, accuracy will therefore need to be verified by survey. Sketch proposals have not been considered in respect of CDM Regulations.

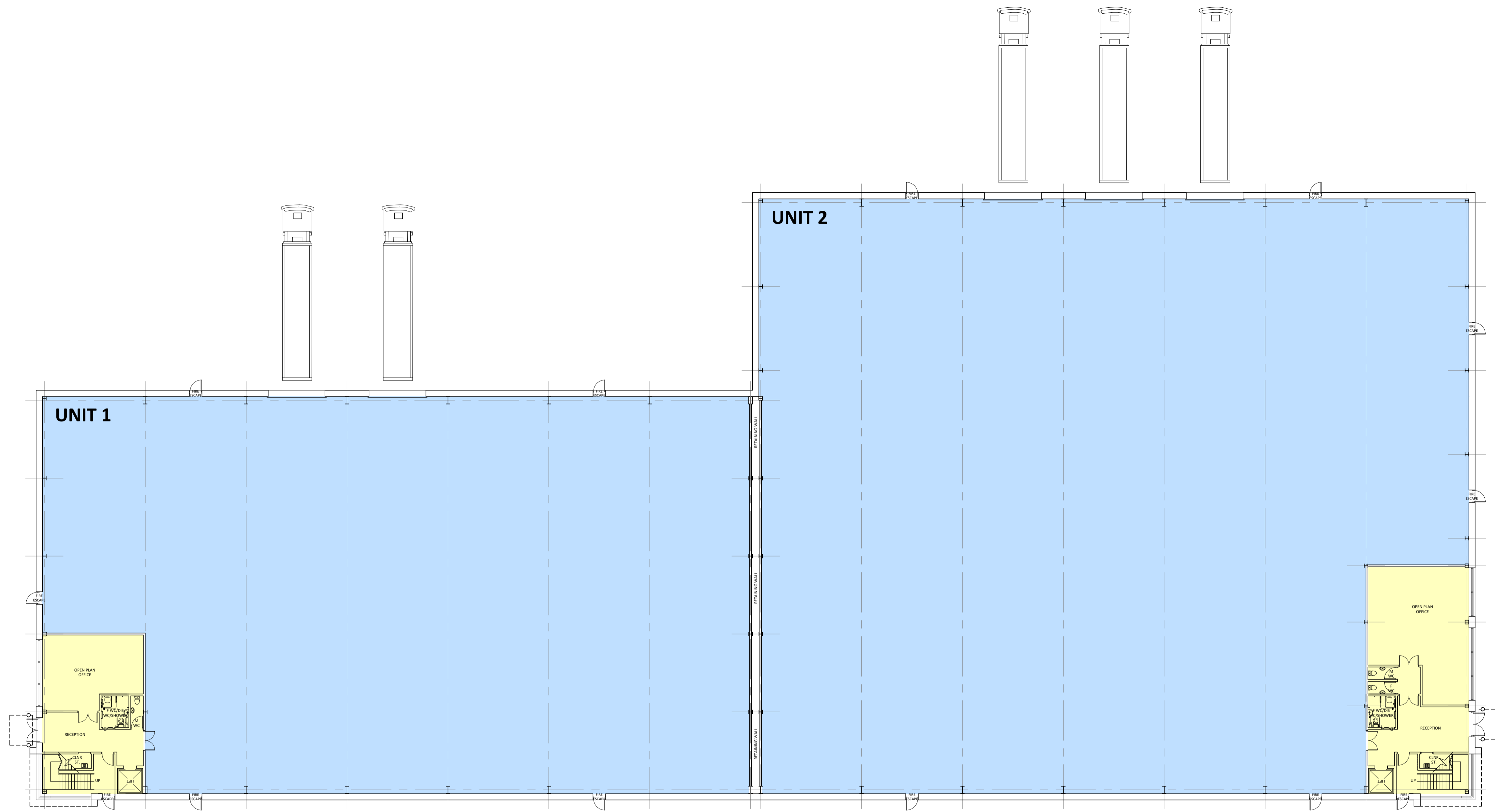

GROUND FLOOR PLAN

SANITARY PROVISION
 OFFICE GROSS FLOOR AREA 2,000 SQFT (186 SQM)
 OFFICE APPROXIMATE NET FLOOR AREA AT 85% N/A 1,700 SQFT (158 SQM)
 OCCUPANCY AT 1 PERSON PER 7 SQM (2)
 OCCUPANCY BY SEX AT 60/40 SPLIT 15M 13F
 MIN MALE PROVISION: 2 No. W.C.'S 2 No. W.H.B'S
 MIN FEMALE PROVISION: 2 No. W.C.'S 2 No. W.H.B'S

SANITARY PROVISION
 OFFICE GROSS FLOOR AREA 3,000 SQFT (279 SQM)
 OFFICE APPROXIMATE NET FLOOR AREA AT 85% N/A 2,550 SQFT (237 SQM)
 OCCUPANCY AT 1 PERSON PER 7 SQM (4)
 OCCUPANCY BY SEX AT 60/40 SPLIT 20M 17F
 MIN MALE PROVISION: 3 No. W.C.'S 3 No. W.H.B'S
 MIN FEMALE PROVISION: 3 No. W.C.'S 3 No. W.H.B'S

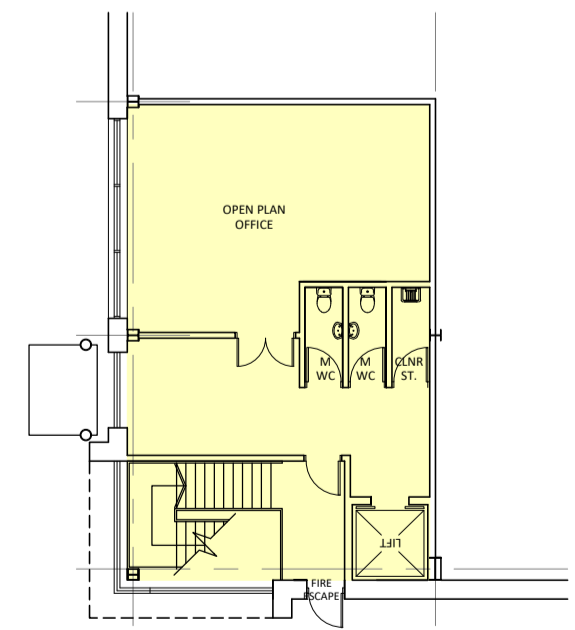

FIRST FLOOR OFFICES

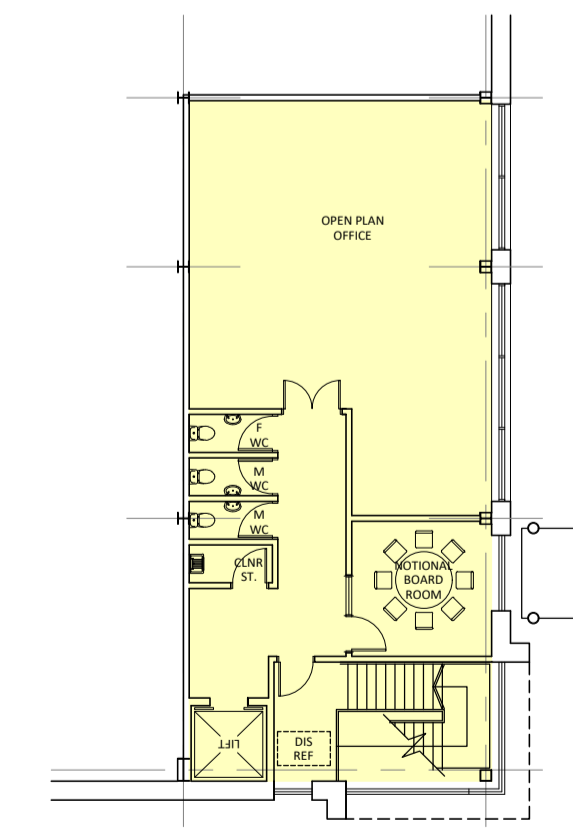

FIRST FLOOR OFFICES

Notes:

Rev	Date	Note
A	23/09/21	Updated to suit LPA comments

**UNIT 1 & 2
 SCHEDULE OF ACCOMMODATION:**

UNIT 1	
UNIT:	18,000 SQFT GIA
OFFICE:	2,000 SQFT GIA
(10% 2 STOREY)	
TOTAL:	20,000 SQFT GIA
UNIT 2	
UNIT:	27,000 SQFT GIA
OFFICE:	3,000 SQFT GIA
(10% 2 STOREY)	
TOTAL:	30,000 SQFT GIA
UNIT 1 & 2	
TOTAL:	50,000 SQFT GIA

PLANNING



bhpdesign
 St. Paul's Place, 40 St. Paul's Square, Birmingham,
 B3 1FQ, United Kingdom
 t. +44(0)121 314 6618 e : info@bhp-design.co.uk

CLIENT: CONEYGRE REDEVELOPMENTS LTD
 PROJECT: LAND OFF CONEYGRE ROAD TIPTON
 TITLE: UNIT 1 & 2 FLOOR PLANS - AS PROPOSED

Scale: 1:200 @ A1	Date: AUG 2021
Design: -	Draft: JC
Drg No: 19-103-PA-04	Revision: A

© This drawing and the building works depicted are the copyright of BHP Design LLP and may not be reproduced or amended except by written permission. No liability will be accepted for amendments made by other persons.

The Contractor is to check and verify all building and site dimensions, levels and sewer invert levels at connection points before work starts. The Contractor is to comply in all respects with current Building Regulations, British Standard Specifications, Building Regulations, Construction (Design & Management) Regulations, Party Wall Act, etc. whether or not specifically stated on this drawing. This drawing must be read with and checked against any structural, geotechnical or other specialist documentation provided.

This drawing is not intended to show details of foundations, ground conditions or ground contaminants. Each area of ground relied upon to support any structure depicted (including drainage) must be investigated by the Contractor. A suitable method of foundation should be provided, allowing for existing ground conditions. Any suspect or fluid ground, contaminants on or within the ground, should be further investigated by a suitable expert. Any earthwork constructions shown indicate typical slopes for guidance only & should be further investigated by a suitable expert.

Where existing trees are to be retained they should be subject to a full Arboricultural Inspection for safety. All trees are to be planted so as to ensure they are a minimum of 5 metres from buildings and 3 metres from drainage and services. A suitable method of foundation is to be provided to accommodate the proposed tree planting.

Sketch proposals are for illustrative purposes only & as such are subject to detailed site investigation including ground conditions/contaminants, drainage, design & planning/conservation negotiations. Sketch proposals may be based upon enlargements of OS sheets & visual estimations of existing site features, accuracy will therefore need to be verified by survey. Sketch proposals have not been considered in respect of CDM Regulations.

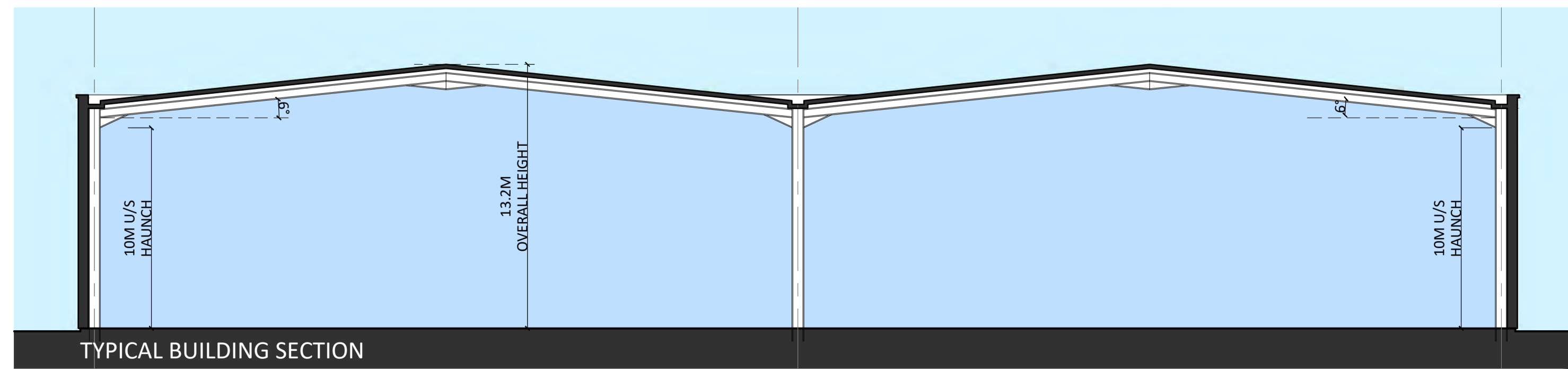
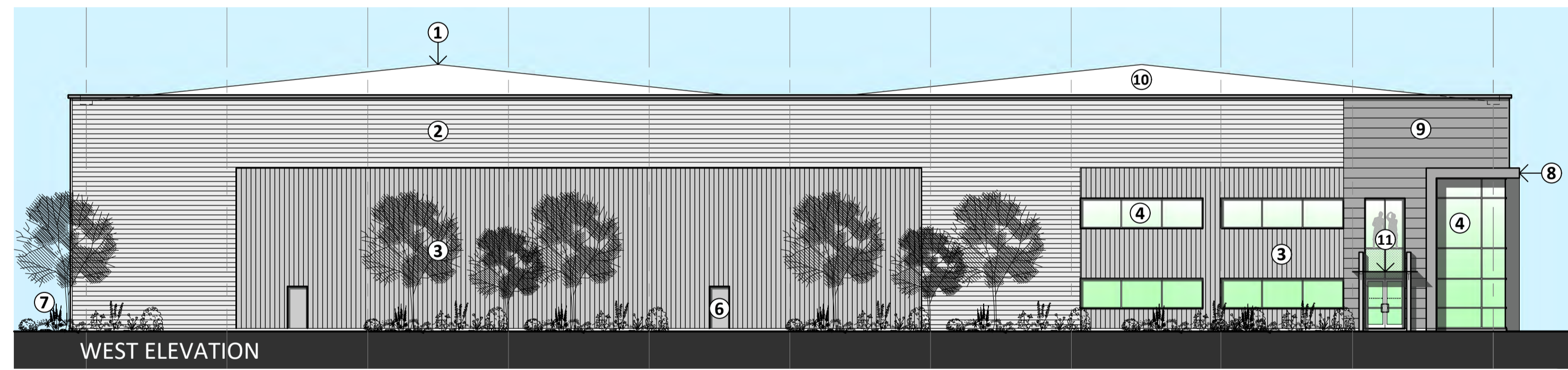
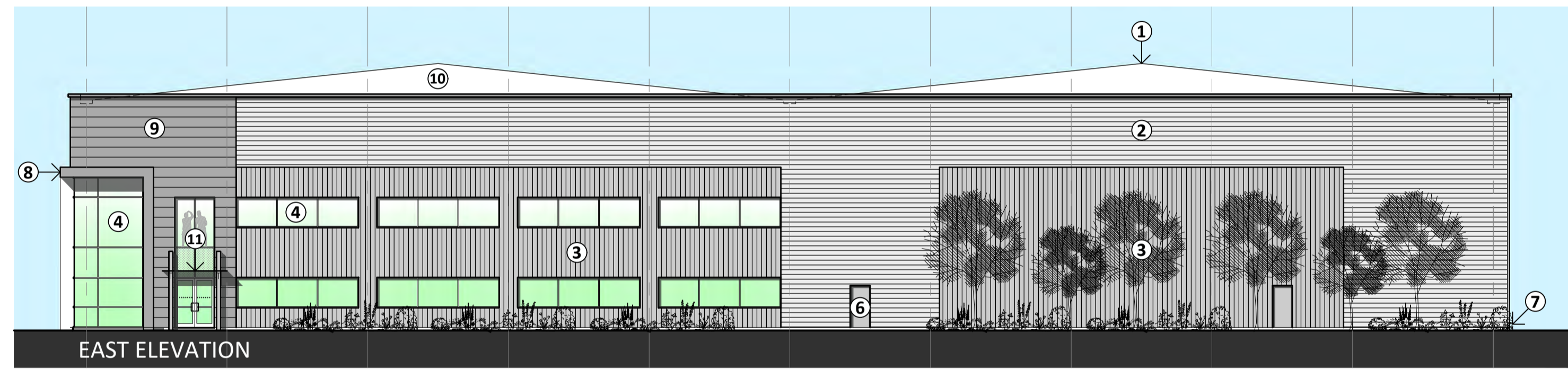
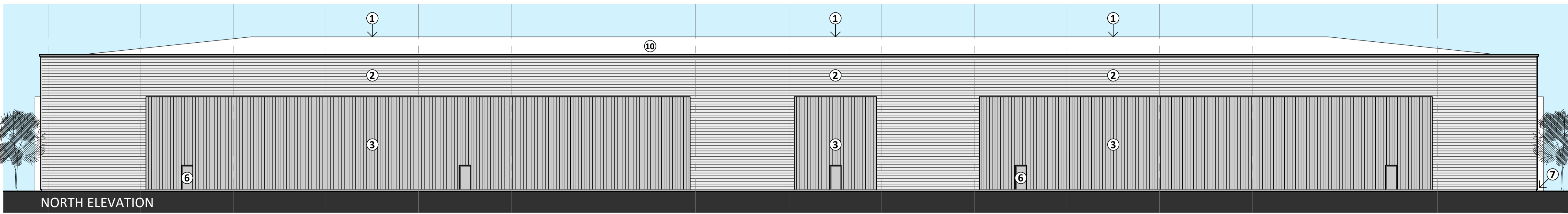
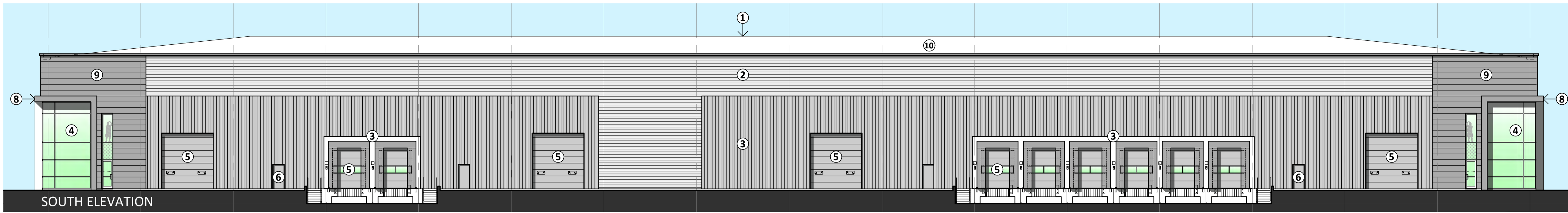

Notes:

Rev	Date	Note
A	23/09/21	Updated to suit LPA comments

PLANNING

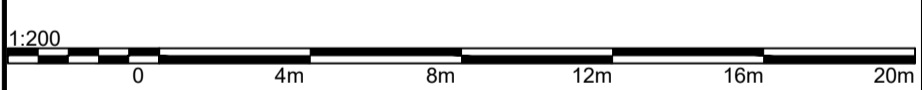

bhpdesign

St. Paul's Place, 40 St. Paul's Square, Birmingham, B3 1FQ, United Kingdom
 t. +44(0)121 314 6618 e : info@bhp-design.co.uk

CLIENT: CONEYGRE REDEVELOPMENTS LTD

PROJECT: LAND OFF CONEYGRE ROAD TIPTON

TITLE: UNIT 3 & 4 ELEVATIONS & SECTION - AS PROPOSED

- SCHEDULE OF BUILDING MATERIALS:**
- ① KINGSPAN KS1000 RW TRAPEZOIDAL PROFILE INSULATED ROOF PANELS OR SIMILAR APPROVED. COLOUR GOOSEWING GREY
 - ② HALF ROUND PROFILE WALL CLADDING. COLOUR METALLIC SILVER (RAL 9006)
 - ③ METAL PROFILED WALL CLADDING. COLOUR BASALT GREY (RAL 7012)
 - ④ ALUMINIUM THERMALLY BROKEN CLEAR DOUBLE GLAZED DOORS & WINDOWS. COLOUR RAL 7016
 - ⑤ SECTIONAL DOORS. RAL 7016
 - ⑥ POWDERCOATED STEEL DOORS. COLOUR RAL 7016
 - ⑦ GALVANISED PFC GROUND BEAM. COLOUR - TBC
 - ⑧ METTALINE FEATURE BEAM PROFILED EDGE TRIM. COLOUR ANTHRACITE (RAL 7016)
 - ⑨ MICRO RIB CLADDING HORIZONTALLY LAID. COLOUR ANTHRACITE (RAL 7016)
 - ⑩ ROOFLIGHTS (10%) - NATURAL DAYLIGHT TO REACH CORNERS OF UNIT.
 - ⑪ STEEL FABRICATED ENTRANCE CANOPY WITH PLANAR GLASS ROOF FULL SPECIFICATION PAINT FINISH. COLOUR: WHITE

Scale:	1:200 @ A1	Date:	AUG 2021
Design:	-	Draft:	SL
Drg No:	19-103-PA-08	Revision:	A

© This drawing and the building works depicted are the copyright of BHP Design LLP and may not be reproduced or transmitted in any form or by any means, electronic, mechanical, photocopying, recording, or by any information storage and retrieval system, without the prior written permission of BHP Design LLP.

The Contractor is to check and verify all building and site dimensions, levels and levels of work before work starts. The Contractor is to comply in all respects with current Building Regulations, Where Standard Specifications, Building Regulations, Construction (Design & Management) Regulations, Part M of the Building Regulations and any other applicable regulations. The drawings must be read with and checked against any structural, geotechnical or other specialist documentation provided.

The drawings are not intended to show details of foundations, ground conditions or ground movements. Each area of ground related work to support any structure designed (including steelwork) must be investigated by the Contractor. A suitable method of foundation should be provided allowing for ground conditions. Any removal of soil ground, contamination on or within the ground should be further investigated by a suitable expert. Any subsidence measurements should include typical areas for guidance only.

Where existing trees are to be retained they should be subject to a full Arboricultural Inspection for safety. All trees are to be protected to as to ensure they are protected (if needed) from buildings and / or trees prevent the planting.

Sketch proposals are for illustrative purposes only & as such are subject to detailed site investigation including ground conditions, ground levels, design & geotechnical investigations. Sketch proposals may be based upon assumptions of EC, sheets & visual estimations of existing site features, accuracy and feasibility need to be verified to survey. Sketch proposals have not been considered in respect of CDM Regulations.

Rev	Date	Note
A	23/09/21	Updated to suit LPA comments

**UNIT 3 & 4
SCHEDULE OF ACCOMMODATION:**

UNIT 3	
UNIT:	54,000 SQFT GIA
OFFICE: (10% 2 STOREY)	6,000 SQFT GIA
TOTAL:	60,000 SQFT GIA
UNIT 4	
UNIT:	36,000 SQFT GIA
OFFICE: (10% 2 STOREY)	4,000 SQFT GIA
TOTAL:	40,000 SQFT GIA
UNIT 3 & 4	
TOTAL:	100,000 SQFT GIA

PLANNING

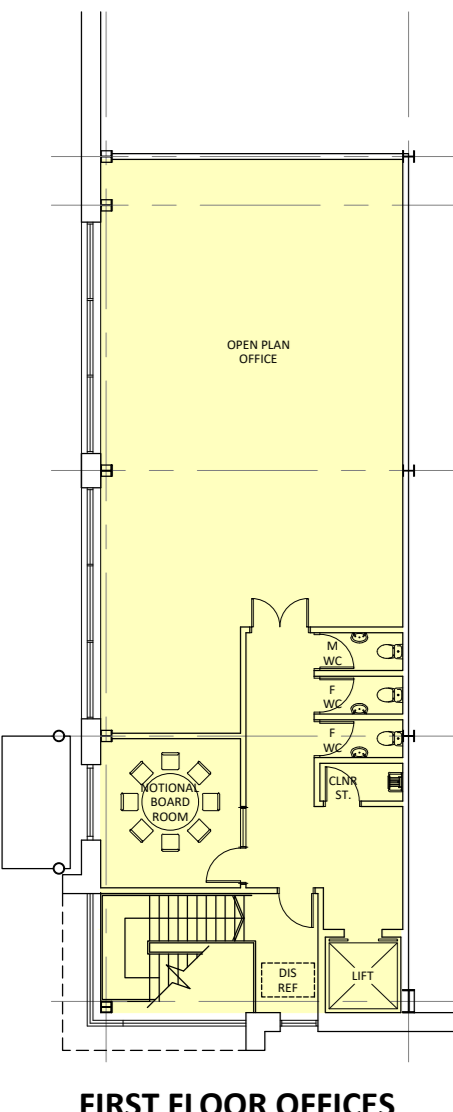
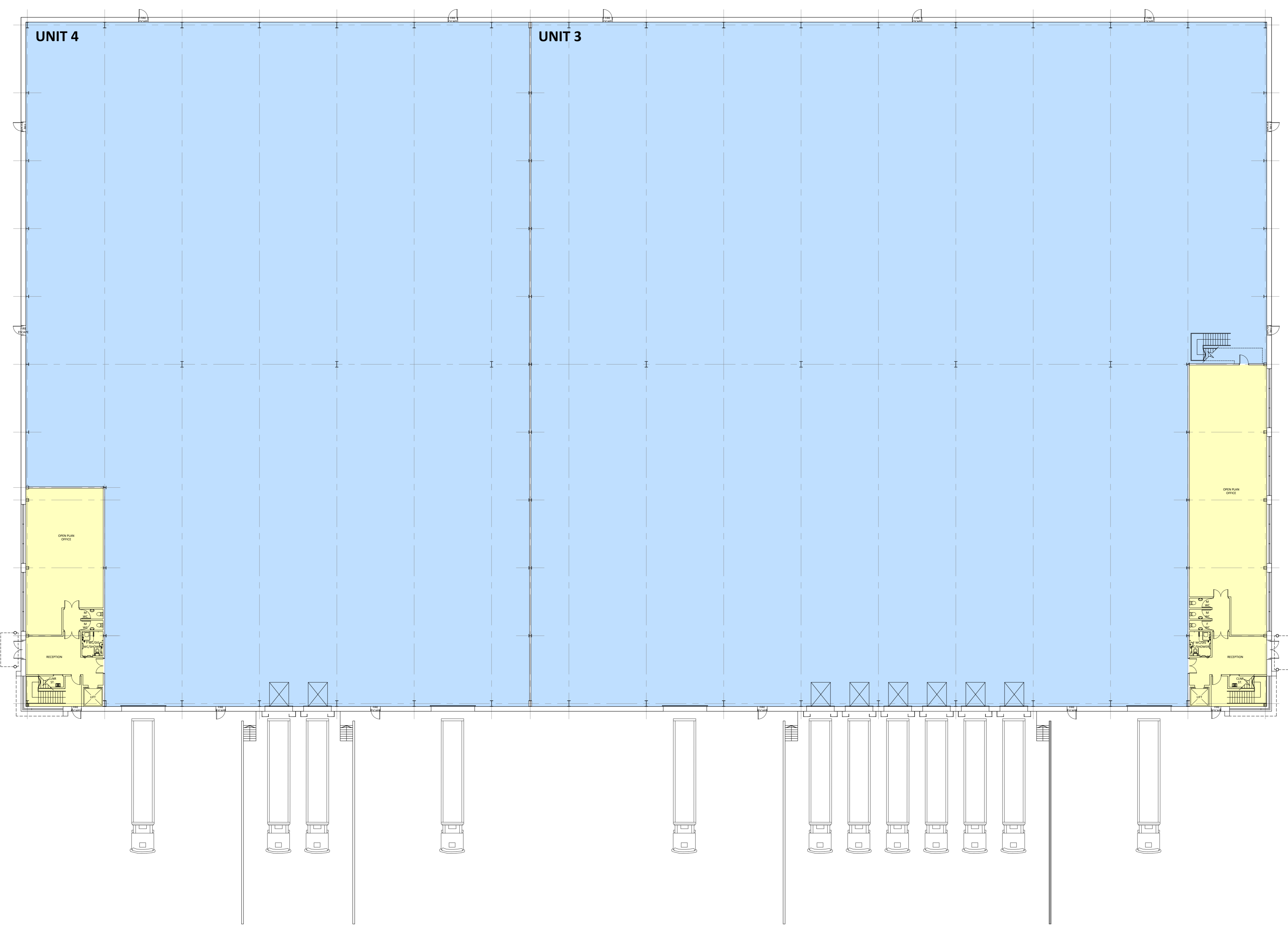

FIRST FLOOR OFFICES

SANITARY PROVISION
OFFICE GROSS FLOOR AREA 4,000 SQFT (372 SQM)
OFFICE APPROXIMATE NET FLOOR AREA AT 85% N/G 3,400 SQFT (316 SQM)
OCCUPANCY AT 1 PERSON PER 7 SQM: 45
OCCUPANCY BY SEX AT 60/60 SPLIT 27M 27F
MIN MALE PROVISION: 3 No. WCs 3 No. WHB'S
MIN FEMALE PROVISION: 3 No. WCs 3 No. WHB'S

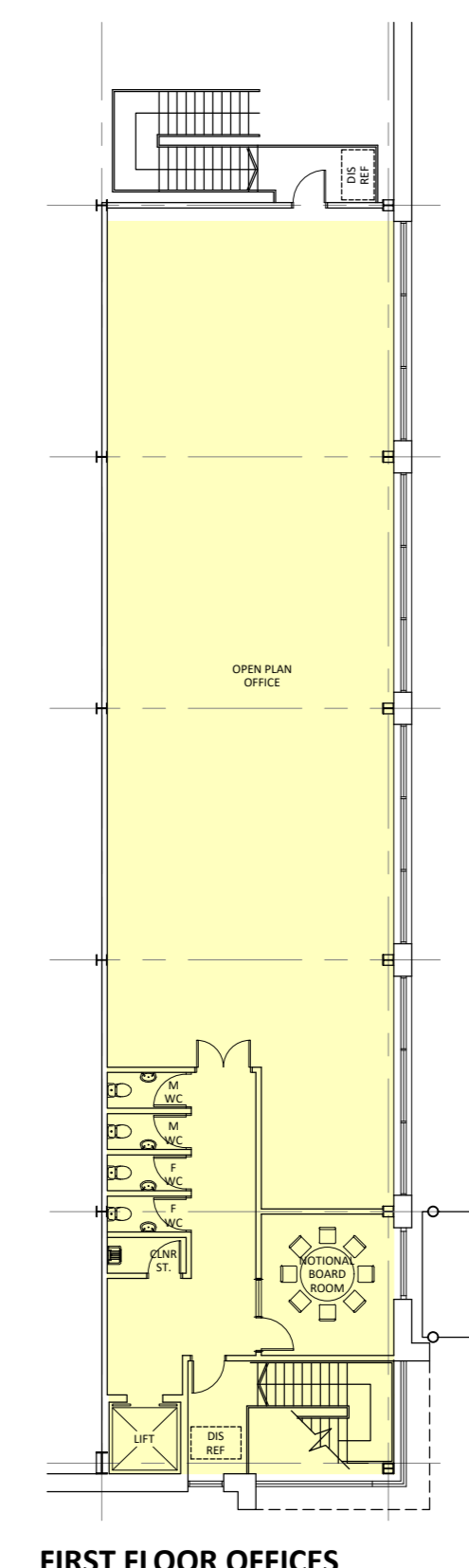

FIRST FLOOR OFFICES

SANITARY PROVISION
OFFICE GROSS FLOOR AREA 6,000 SQFT (558 SQM)
OFFICE APPROXIMATE NET FLOOR AREA AT 85% N/G 5,100 SQFT (474 SQM)
OCCUPANCY AT 1 PERSON PER 7 SQM: 68
OCCUPANCY BY SEX AT 60/60 SPLIT 40M 40F
MIN MALE PROVISION: 4 No. WCs 4 No. WHB'S
MIN FEMALE PROVISION: 4 No. WCs 4 No. WHB'S

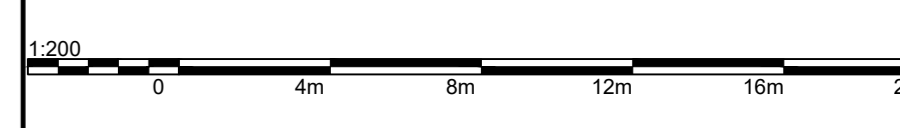

bhpdesign
St. Paul's Place, 40 St. Paul's Square, Birmingham,
B3 1FQ, United Kingdom
t: +44(0)121 314 6618 e: info@bhp-design.co.uk

CLIENT: CONEYGRE REDEVELOPMENTS LTD
PROJECT: LAND OFF CONEYGRE ROAD TIPTON
TITLE: UNIT 3 & 4 FLOOR PLANS - AS PROPOSED

Scale: 1:200 @ A0	Date: AUG 2021
Design: DFC	Draft: SL
Dirg No: 19-103-PA-05	Revision: A

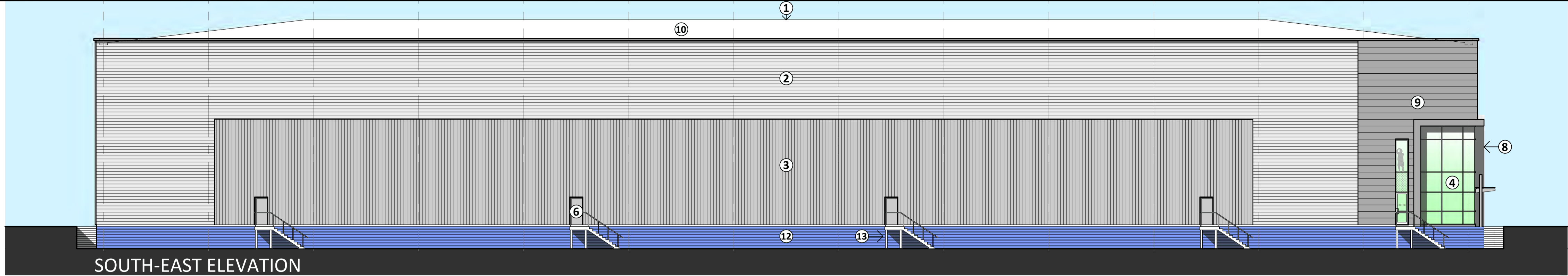

SOUTH-EAST ELEVATION



NORTH-WEST ELEVATION

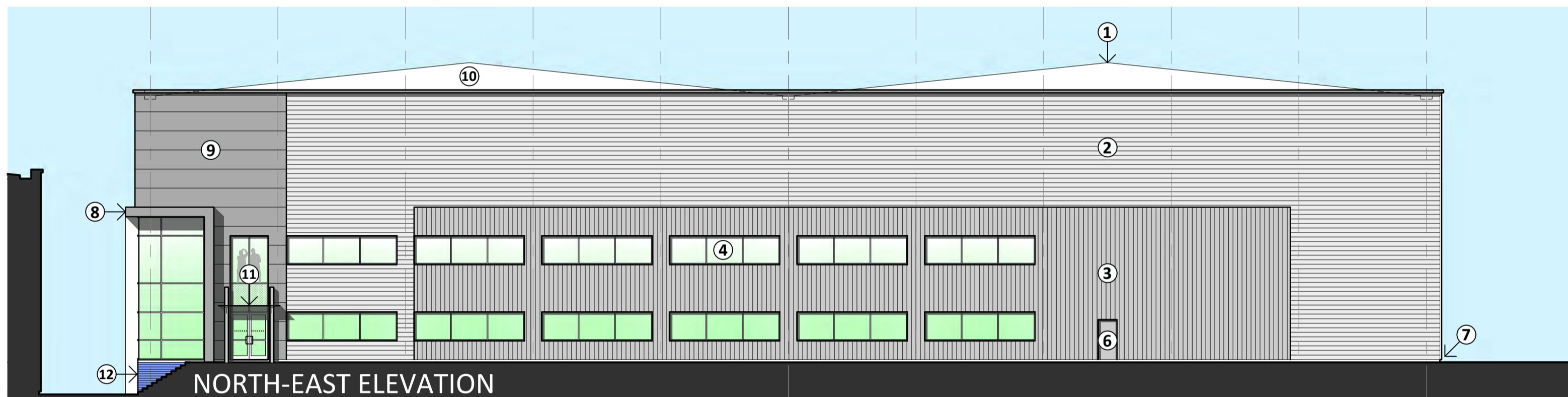

NORTH-EAST ELEVATION

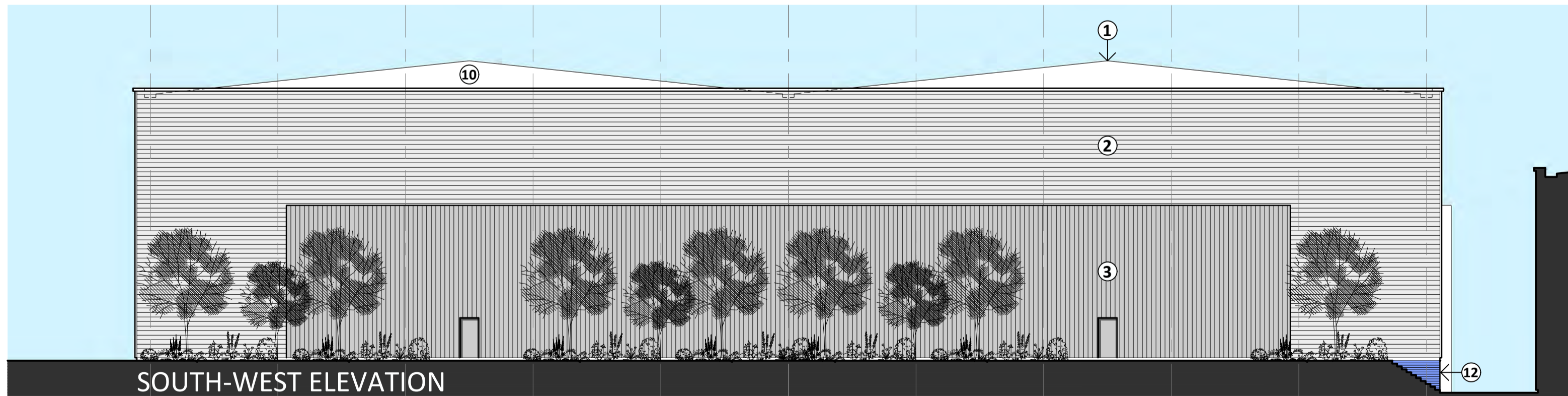

SOUTH-WEST ELEVATION

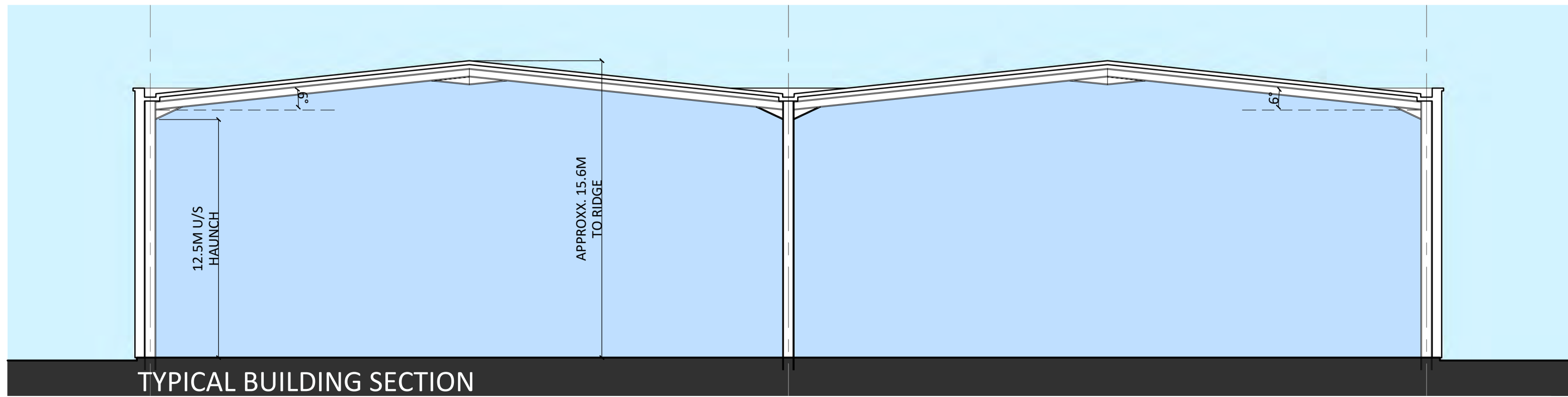

TYPICAL BUILDING SECTION

SCHEDULE OF BUILDING MATERIALS:

- ① KINGSPAN KS1000 RW TRAPEZOIDAL PROFILE INSULATED ROOF PANELS OR SIMILAR APPROVED. COLOUR GOOSEWING GREY
- ② HALF ROUND PROFILE WALL CLADDING. COLOUR METALLIC SILVER (RAL 9006)
- ③ METAL PROFILED WALL CLADDING. COLOUR BASALT GREY (RAL 7012)
- ④ ALUMINIUM THERMALLY BROKEN CLEAR DOUBLE GLAZED DOORS & WINDOWS. COLOUR RAL 7016
- ⑤ SECTIONAL DOORS. RAL 7016
- ⑥ POWDERCOATED STEEL DOORS. COLOUR RAL 7016
- ⑦ GALVANISED PFC GROUND BEAM. COLOUR - TBC
- ⑧ METTALINE FEATURE BEAM PROFILED EDGE TRIM. COLOUR ANTHRACITE (RAL 7016)
- ⑨ MICRO RIB CLADDING HORIZONTALLY LAID. COLOUR ANTHRACITE (RAL 7016)
- ⑩ ROOFLIGHTS (10%) - NATURAL DAYLIGHT TO REACH CORNERS OF UNIT.
- ⑪ STEEL FABRICATED ENTRANCE CANOPY WITH PLANAR GLASS ROOF FULL SPECIFICATION PAINT FINISH. COLOUR: WHITE
- ⑫ ENGINEERING BRICKWORK TO FORM BUILDING RETENTION. COLOUR BLUE
- ⑬ STEEL FABRICATED FIRE ESCAPE STAIRCASE WITH KEY CLAMP STYLE BALLUSTRADING

© This drawing and the building works depicted are the copyright of BHP Design LLP and may not be reproduced or amended except by written permission. No liability will be accepted for amendments made by other persons.

The Contractor is to check and verify all building and site dimensions, levels and sewer invert levels at connection points before work starts. The Contractor is to comply in all respects with current Building Regulations, Party Wall Act, etc. whether or not specifically stated on this drawing. This drawing must be read with and checked against any structural, geotechnical or other specialist documentation provided.

This drawing is not intended to show details of foundations, ground conditions or ground contaminants. Each area of ground relied upon to support any structure depicted (including drainage) must be investigated by the Contractor. A suitable method of foundation should be provided, allowing for existing ground conditions. Any suspect or fluid ground, contaminants on or within the ground, should be further investigated by a suitable expert. Any earthwork constructions shown indicate typical slopes for guidance only & should be further investigated by a suitable expert.

Where existing trees are to be retained they should be subject to a full Arboricultural Inspection for safety. All trees are to be planted so as to ensure they are a minimum of 5 metres from buildings and 3 metres from drainage and services. A suitable method of foundation is to be provided to accommodate the proposed tree planting.

Sketch proposals are for illustrative purposes only & as such are subject to detailed site investigation including ground conditions/contaminants, drainage, design & planning/density negotiations. Sketch proposals may be based upon enlargements of OS sheets & visual estimations of existing site features, accuracy will therefore need to be verified by survey. Sketch proposals have not been considered in respect of CDM Regulations.

Rev	Date	Note
A	23/09/21	Updated to suit LPA comments

PLANNING

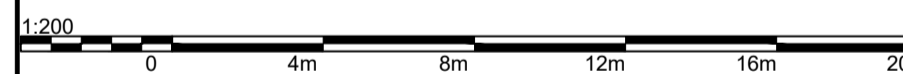

bhpdesign
 St. Paul's Place, 40 St. Paul's Square, Birmingham,
 B3 1FQ, United Kingdom
 t. +44(0)121 314 6618 e : info@bhp-design.co.uk

CLIENT: CONEYGRE REDEVELOPMENTS LTD
 PROJECT: LAND OFF CONEYGRE ROAD TIPTON
 TITLE: UNIT 5 ELEVATIONS & SECTION - AS PROPOSED

Scale:	1:200 @ A1	Date:	JULY 2021
Design:	-	Draft:	JC
Drg No:	19-103-PA-09	Revision:	A

© This drawing and the building works depicted are the copyright of BHP Design LLP and may not be reproduced or amended except by written permission. No liability will be accepted for amendments made by other persons.

The Contractor is to check and verify all building and site dimensions, levels and sewer invert levels at connection points before work starts. The Contractor is to comply in all respects with current Building Regulations, British Standard Specifications, Building Regulations, Construction (Design & Management) Regulations, Party Wall Act, etc. whether or not specifically stated on this drawing. This drawing must be read with and checked against any structural, geotechnical or other specialist documentation provided.

This drawing is not intended to show details of foundations, ground conditions or ground contaminants. Each area of ground relied upon to support any structure depicted (including drainage) must be investigated by the Contractor. A suitable method of foundation should be provided, allowing for existing ground conditions. Any suspect or fluid ground, contaminants on or within the ground, should be further investigated by a suitable expert. Any earthwork constructions shown indicate typical slopes for guidance only & should be further investigated by a suitable expert.

Where existing trees are to be retained they should be subject to a full Arboricultural Inspection for safety. All trees are to be planted so as to ensure they are a minimum of 5 metres from buildings and 3 metres from drainage and services. A suitable method of foundation is to be provided to accommodate the proposed tree planting.

Sketch proposals are for illustrative purposes only & as such are subject to detailed site investigation including ground conditions/contaminants, drainage, design & planning/conservation negotiations. Sketch proposals may be based upon enlargements of OS sheets & visual estimations of existing site features, accuracy will therefore need to be verified by survey. Sketch proposals have not been considered in respect of CDM Regulations.

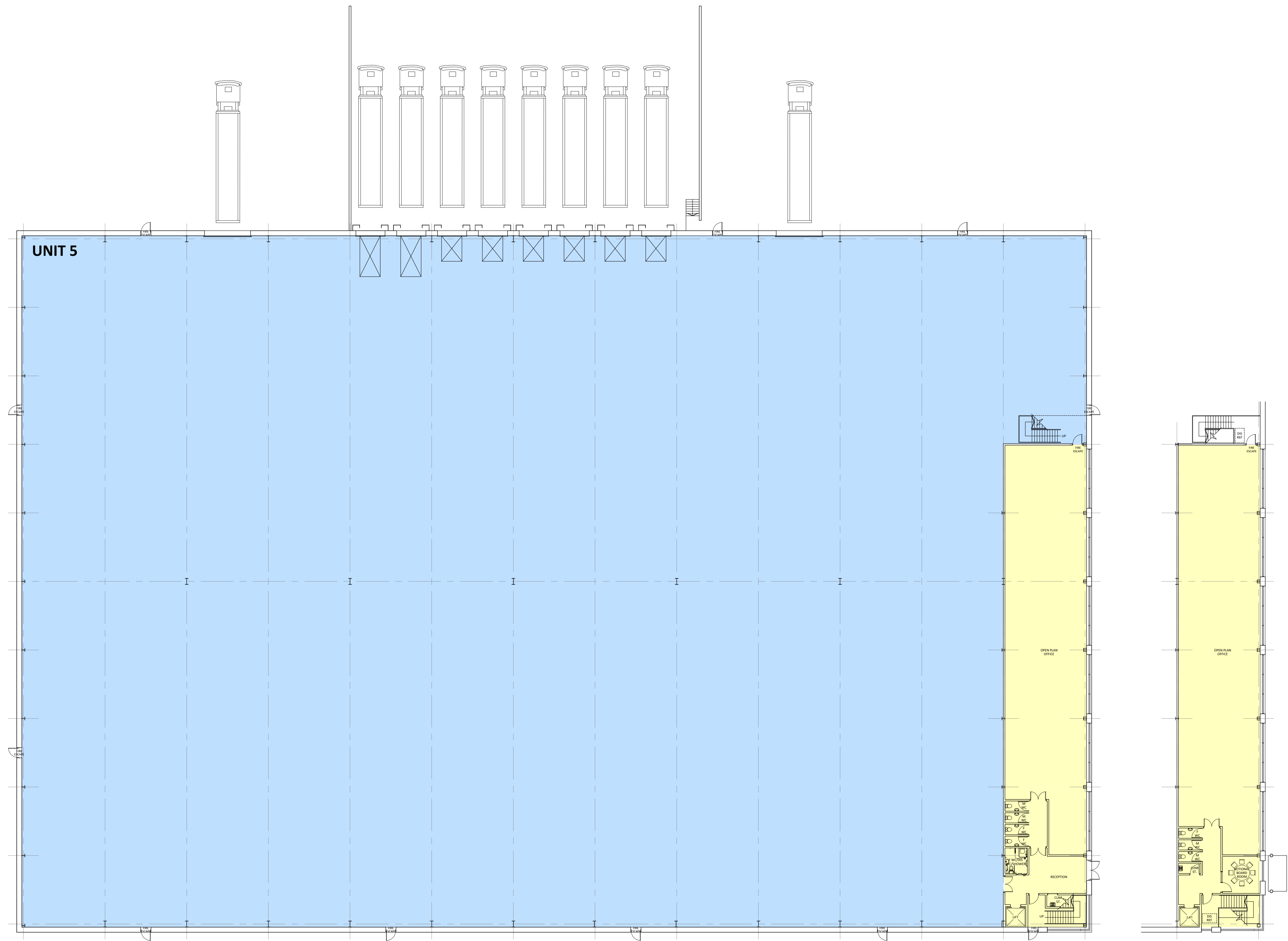

UNIT 5

GROUND FLOOR PLAN

SANITARY PROVISION
 OFFICE GROSS FLOOR AREA 8,000 SQFT (743 SQM)
 OFFICE APPROXIMATE NET FLOOR AREA AT 82% N/A/S 6,800 SQFT (633 SQM)
 OCCUPANCY AT 1 PERSON PER 7 SQM (30)
 OCCUPANCY BY SEX AT 50/50 SPLIT 54M/54F
 MIN MALE PROVISION: 5 NO. W.C'S 5 NO. W.H.B'S
 MIN FEMALE PROVISION: 5 NO. W.C'S 5 NO. W.H.B'S

FIRST FLOOR OFFICES

Notes:

Rev	Date	Note
A	23/09/21	Updated to suit LPA comments

**UNIT 5
SCHEDULE OF ACCOMMODATION:**

UNIT:	72,000 SQFT GIA
OFFICE: (10% 2 STOREY)	8,000 SQFT GIA
TOTAL:	80,000 SQFT GIA

PLANNING

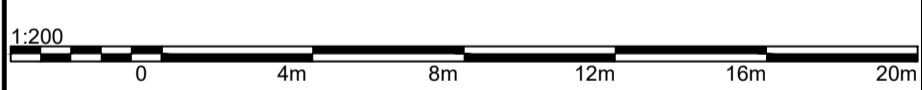

bhpdesign
 St. Paul's Place, 40 St. Paul's Square, Birmingham,
 B3 1FQ, United Kingdom
 t. +44(0)121 314 6618 e : info@bhp-design.co.uk

CLIENT: CONEYGRE REDEVELOPMENTS LTD
 PROJECT: LAND OFF CONEYGRE ROAD TIPTON
 TITLE: UNIT 5 FLOOR PLANS - AS PROPOSED

Scale: 1:200 @ A1	Date: AUG 2021
Design: -	Draft: JC
Drg No: 19-103-PA-06	Revision: A

© This drawing and the building works depicted are the copyright of BHP Design LLP and may not be reproduced or amended except by written permission. No liability will be accepted for amendments made by other persons.

The Contractor is to check and verify all building and site dimensions, levels and sewer invert levels at connection points before work starts. The Contractor is to comply in all respects with current Building Regulations, British Standard Specifications, Building Regulations, Construction (Design & Management) Regulations, Party Wall Act, etc. whether or not specifically stated on this drawing. This drawing must be read with and checked against any structural, geotechnical, or other specialist documentation provided.

This drawing is not intended to show details of foundations, ground conditions or ground contaminants. Each area of ground relied upon to support any structure depicted (including drainage) must be investigated by the Contractor. A suitable method of foundation should be provided, allowing for existing ground conditions. Any suspect or fluid ground, contaminants on or within the ground, should be further investigated by a suitable expert. Any earthwork constructions shown indicate typical slopes for guidance only & should be further investigated by a suitable expert.

Where existing trees are to be retained they should be subject to a full Arboricultural Inspection for safety. All trees are to be planted so as to ensure they are a minimum of 5 metres from buildings and 3 metres from drainage and services. A suitable method of foundation is to be provided to accommodate the proposed tree planting.

Sketch proposals are for illustrative purposes only & as such are subject to detailed site investigation including ground conditions/contaminants, drainage, design & planning/conservation negotiations. Sketch proposals may be based upon enlargements of OS sheets & visual estimations of existing site features, accuracy will therefore need to be verified by survey. Sketch proposals have not been considered in respect of CDM Regulations.

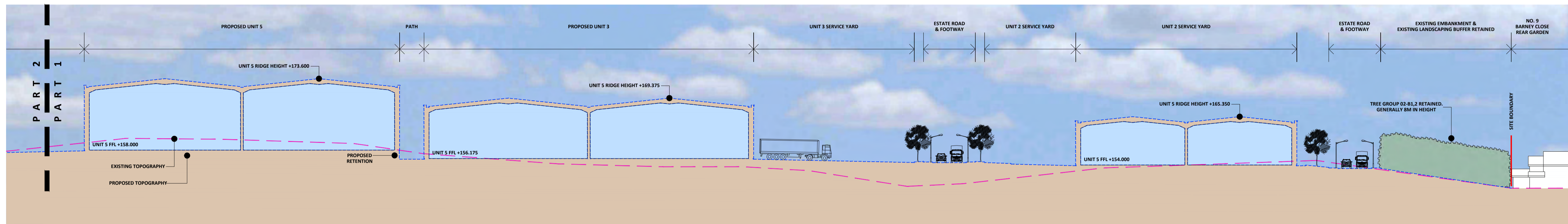

SECTION A - A PART 1 (1:500)

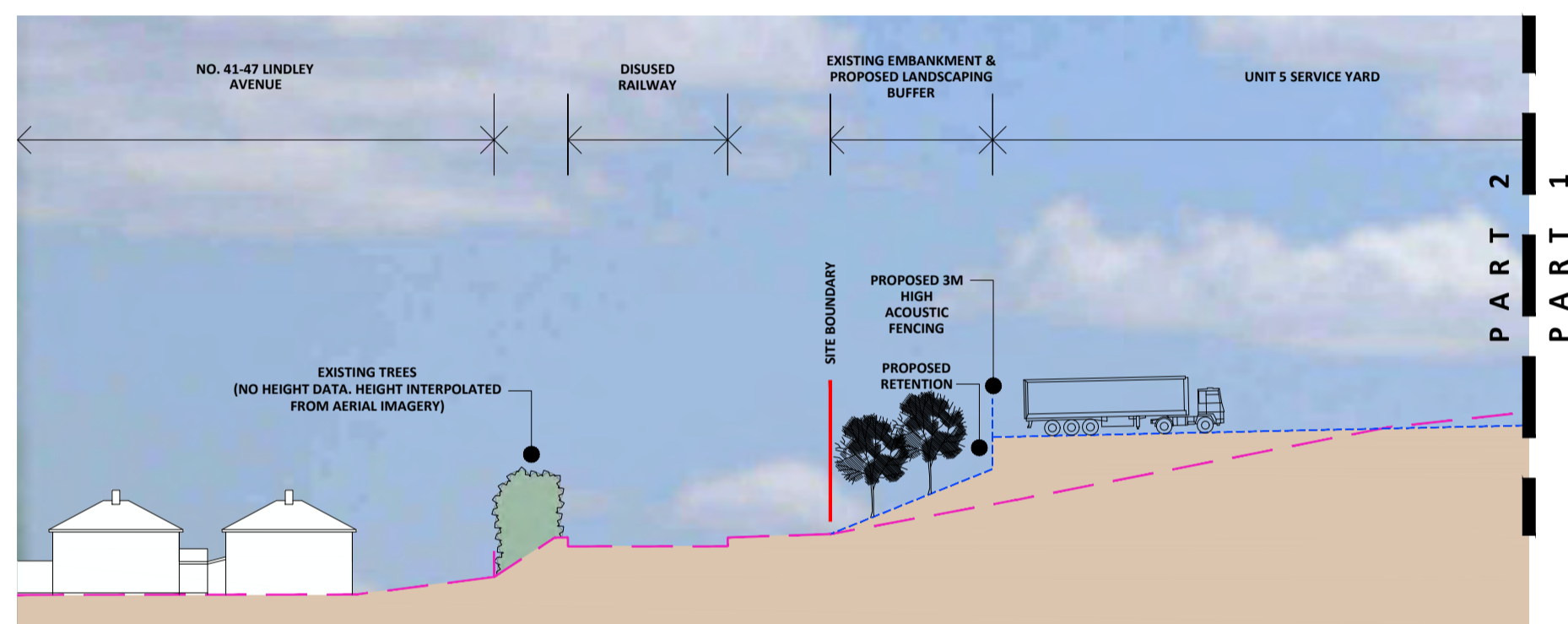

SECTION A - A PART 2 (1:500)

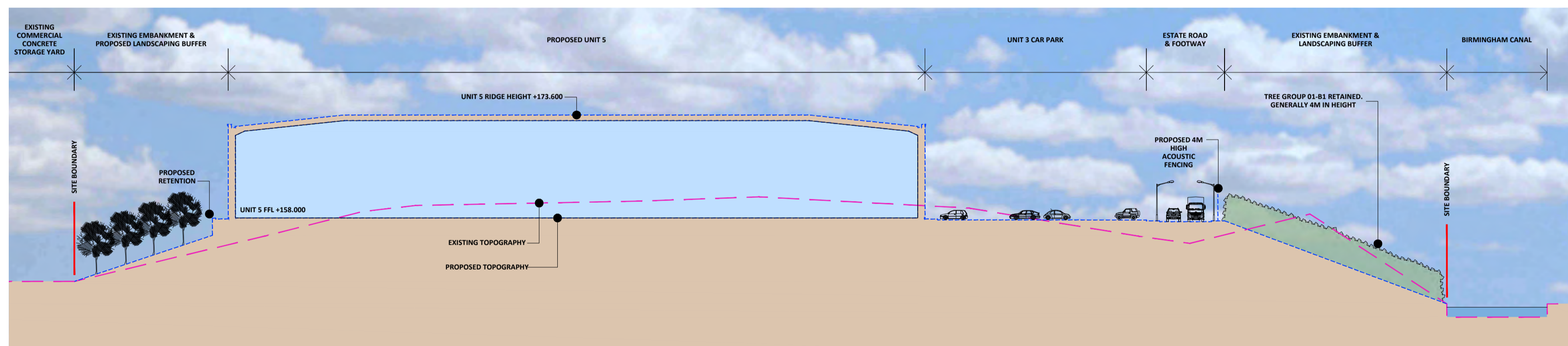

SECTION B - B (1:500)

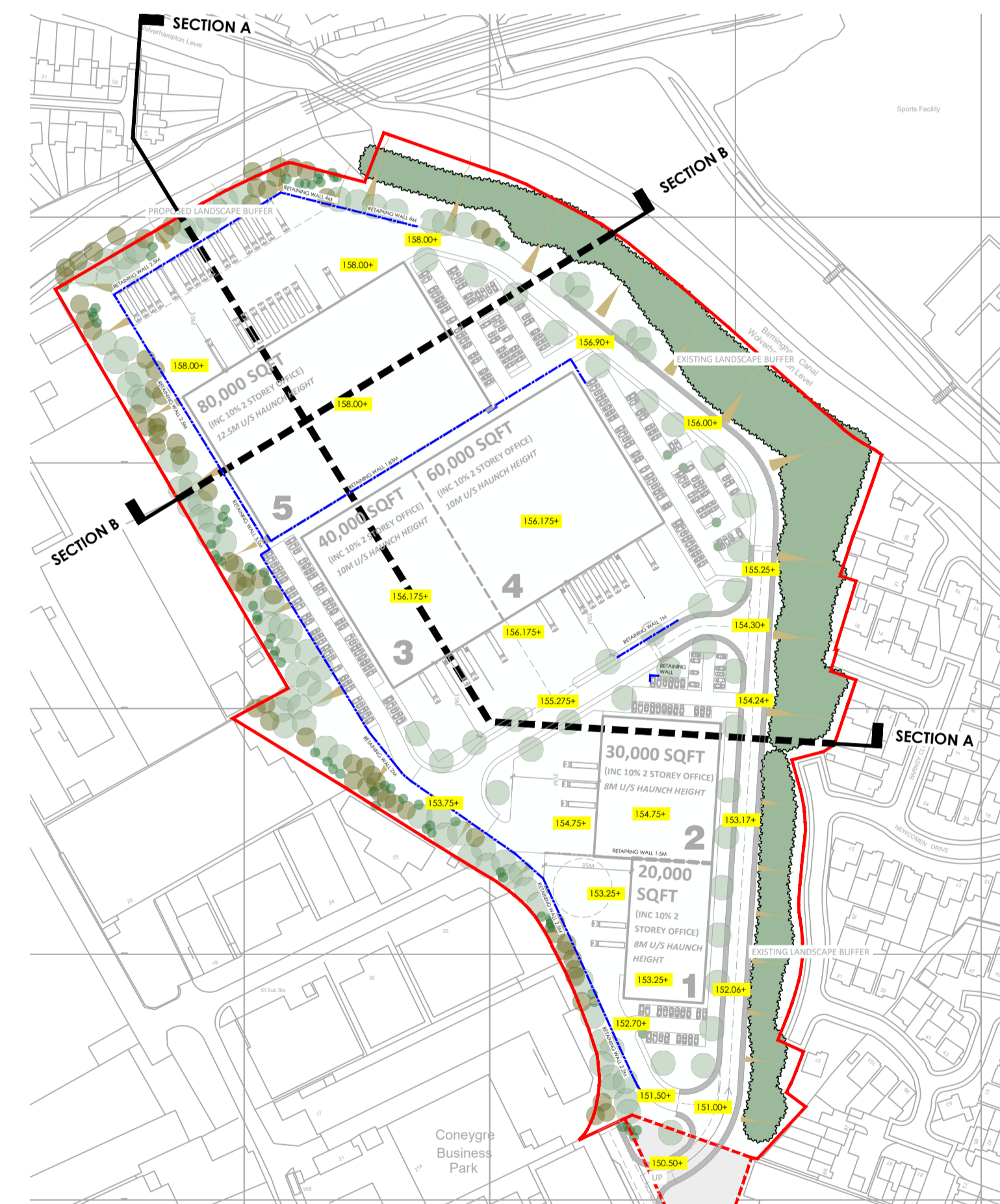

KEY (1:2000)

Rev	Date	Note
A	23/09/21	Updated to suit LPA comments
B	09/11/21	Updated to suit Urban design comments received 03/11/21

Notes:

Rev	Date	Note
A	23/09/21	Updated to suit LPA comments
B	09/11/21	Updated to suit Urban design comments received 03/11/21

Notes:

Rev	Date	Note
A	23/09/21	Updated to suit LPA comments
B	09/11/21	Updated to suit Urban design comments received 03/11/21

Notes:

Rev	Date	Note
A	23/09/21	Updated to suit LPA comments
B	09/11/21	Updated to suit Urban design comments received 03/11/21

Notes:

Rev	Date	Note
A	23/09/21	Updated to suit LPA comments
B	09/11/21	Updated to suit Urban design comments received 03/11/21

Notes:

Rev	Date	Note
A	23/09/21	Updated to suit LPA comments
B	09/11/21	Updated to suit Urban design comments received 03/11/21

Notes:

Rev	Date	Note
A	23/09/21	Updated to suit LPA comments
B	09/11/21	Updated to suit Urban design comments received 03/11/21

Notes:

Rev	Date	Note
A	23/09/21	Updated to suit LPA comments
B	09/11/21	Updated to suit Urban design comments received 03/11/21

Notes:

Rev	Date	Note
A	23/09/21	Updated to suit LPA comments
B	09/11/21	Updated to suit Urban design comments received 03/11/21

Notes:

Rev	Date	Note
A	23/09/21	Updated to suit LPA comments
B	09/11/21	Updated to suit Urban design comments received 03/11/21

Notes:

Rev	Date	Note
A	23/09/21	Updated to suit LPA comments
B	09/11/21	Updated to suit Urban design comments received 03/11/21

Notes:

Rev	Date	Note
A	23/09/21	Updated to suit LPA comments
B	09/11/21	Updated to suit Urban design comments received 03/11/21

Notes:

Rev	Date	Note
A	23/09/21	Updated to suit LPA comments
B	09/11/21	Updated to suit Urban design comments received 03/11/21

Notes:

Rev	Date	Note
A	23/09/21	Updated to suit LPA comments
B	09/11/21	Updated to suit Urban design comments received 03/11/21

PLANNING

Revisions: Amendment: Date: Name:

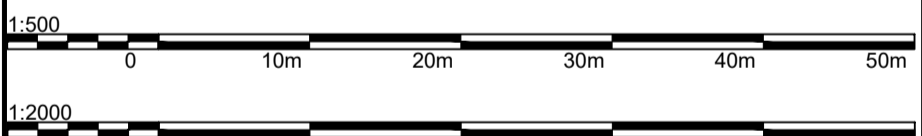

St. Paul's Place, 40 St. Paul's Square, Birmingham, B3 1FQ, United Kingdom
t. +44(0)121 314 6618 e: info@bhp-design.co.uk

CLIENT: CONEYGRE REDEVELOPMENTS LTD

PROJECT: LAND OFF CONEYGREE ROAD TIPTON

TITLE: ILLUSTRATIVE SITE SECTIONS

Scale: AS SHOWN @ A1 Date: AUG 2021

Design: DFC Draft: JC

Drg No: 19-103-PA-10 Revision: B

Species Rich Wildflower Meadow



Native Structural Tree Planting

Quercus robur, Tilia cordata, Fagus sylvatica, Carpinus betulus, Sorbus aucuparia, Acer campestre, Pinus sylvestris, Alnus glutinosa



NOTES:
Based upon the Ordnance Survey map with permission of The Controller of Her Majesty's Stationery Office. © Crown Copyright.
Aspect Landscape Planning Ltd, West Court, Harwick Business Park, Noral Way, Banbury OX16 2AF.
Licence 10004245
Copyright reserved



Key:

- Application Site Boundary
- Existing/Retained Vegetation
- Proposed Ornamental Shrub
- Proposed Ornamental Hedge
- Proposed Native Shrub
- Proposed Street Trees
- Proposed Native Structural Tree Planting
- Proposed Security Fencing
- Proposed Species Rich Wildflower Meadow

Proposed native structural tree and shrub planting to the northern and western site boundaries. This buffer planting will aid in reinforcing the site boundaries to existing development and create a green edge to the site.

Proposed wildflower margins will increase the sites biodiversity credentials and allow for maintenance strips adjacent to hard standing areas

Existing boundary vegetation will be retained and enhanced where possible. This will maintain existing habitats for wildlife and ensure impact on the visual amenity of the development is minimal.

Ornamental tree, hedge and shrub planting are proposed within the development. This will aid in creating vertical interest through the planting against the proposed built form and break up of hard standing areas.



Ornamental Planting Mix

- Lavandula angustifolia 'Hidcote'
- Lavandula angustifolia 'Rosea'
- Salvia purpurea
- Cistus corbariensis
- Potentilla fruticosa 'Abbotswood White'
- Hebe 'Nicola's Blush'
- Fuschia 'Mrs Poppo'
- Spiraea nipponica 'Snowmound'
- Escallonia 'Apple Blossom'
- Weigela 'Mount Blanc'
- Euonymus fortunei 'Silver Queen'
- Phormium tenax 'Purpureum'

Proposed Street Tree Planting

- Acer platanoides 'Crimson King'
- Carpinus betulus
- Tilia cordata 'Greenspire'
- Liquidamber styraciflua



Native Boundary Planting



- Shrubs: Hazel (Corylus avellana), Hawthorn (Crataegus monogyna), Common Dogwood (Cornus sanguinea), Wayfaring tree (Viburnum lanata), Guelder Rose (Viburnum opulus), Blackthorn (Prunus spinosa).



Hedge (to be maintained at 1.2m high)
Osmanthus burkwoodii

REV	DATE	NOTE	DRAWN	CHK'D
REVISIONS				

aspect landscape planning

TITLE
Coneygre Road, Tipton
Landscape Masterplan

CLIENT
bhp Design

SCALE	DATE	DRAWN	CHK'D
1:1500 @ A3	AUG 2021	EL	BS
DRAWING NUMBER	REVISION		
7564/ ASP3/ LSP			

This drawing and the building works depicted are the copyright of BHP Design (UK) LTD. and may not be reproduced or amended except by written permission. No liability will be accepted for amendments made by other persons.

The Contractor is to check and verify all building and site dimensions, levels and sewer invert levels at connection points before work starts. The Contractor is to comply in all respects with current Building Legislation, British Standard Specifications, Building Regulations, Construction (Design & Management) Regulations, Party Wall Act, etc. whether or not specifically stated on this drawing. This drawing must be read with and checked against any structural, geotechnical or other specialist documentation provided.

This drawing is not intended to show details of foundations, ground conditions or ground contaminants. Each area of ground relied upon to support any structure depicted (including drainage) must be investigated by the Contractor. A suitable method of foundation should be provided allowing for existing ground conditions. Any suspect or fluid ground, contamination on or within the ground, should be further investigated by a suitable expert. Any earthwork constructions shown indicate typical slopes for guidance only & should be further investigated by a suitable expert.

Where existing trees are to be retained they should be subject to a full Arboricultural Inspection for safety. All trees are to be planted so as to ensure they are a minimum of 5 metres from buildings and 2 metres from drainage and services. A suitable method of foundation is to be provided to accommodate the proposed tree planting.

Sketch proposals are for illustrative purposes only & as such are subject to detailed site investigation including ground conditions/contaminants, drainage, design & planning/density negotiations. Sketch proposals may be based upon enlargements of OS sheets & visual estimations of existing site features, accuracy will therefore need to be verified by survey. Sketch proposals have not been considered in respect of CON Regulations.

Rev	Date	Note
A	23/09/21	Updated to suit LPA comments



PLANNING

Revisions: Amendment: Date: Name:

bhpdesign
 St. Paul's Place, 40 St. Paul's Square, Birmingham,
 B3 1FQ, United Kingdom
 t. +44(0)121 314 6618 e : info@bhp-design.co.uk

CLIENT: CONEYGRE REDEVELOPMENTS LTD
PROJECT: LAND OFF CONEYGREE ROAD TIPTON
TITLE: GROUND LEVEL CGI

Scale: NTS	Date: AUG 2021
Design: DFC	Drawn: WC
Drw No: 19-103-PA-14	Revision: A

ILLUSTRATIVE GROUND LEVEL CGI



This drawing and the building works depicted are the copyright of BHP Design (UK) LTD. and may not be reproduced or amended except by written permission. No liability will be accepted for amendments made by other persons.

The Contractor is to check and verify all building and site dimensions, levels and sewer invert levels at connection points before work starts. The Contractor is to comply in all respects with current Building Legislation, British Standard Specifications, Building Regulations, Construction (Design & Management) Regulations, Party Wall Act, etc. whether or not specifically stated on this drawing. This drawing must be read with and checked against any structural, geotechnical or other specialist documentation provided.

This drawing is not intended to show details of foundations, ground conditions or ground contaminants. Each area of ground relied upon to support any structure depicted (including drainage) must be investigated by the Contractor. A suitable method of foundation should be provided allowing for existing ground conditions. Any suspected or fluid ground, contamination on or within the ground, should be further investigated by a suitable expert. Any eastwork constructions shown indicate typical slopes for guidance only & should be further investigated by a suitable expert.

Where existing trees are to be retained they should be subject to a full Arboricultural Inspection for safety. All trees are to be planted so as to ensure they are a minimum of 5 metres from buildings and 2 metres from drainage and services. A suitable method of foundation is to be provided to accommodate the proposed tree planting.

Sketch proposals are for illustrative purposes only & as such are subject to detailed site investigation including ground conditions/contaminants, drainage, design & planning/conservation negotiations. Sketch proposals may be based upon enlargements of CG sheets & visual estimations of existing site features, accuracy will therefore need to be verified by survey. Sketch proposals have not been considered in respect of CON Regulations.

Notes:

Rev	Date	Note
A	23/09/21	Updated to suit LPA comments

PLANNING

Revisions: Amendment: Date: Name:

bhpdesign
 St. Paul's Place, 40 St. Paul's Square, Birmingham, B3 1FQ, United Kingdom
 t. +44(0)121 314 6618 e : info@bhp-design.co.uk

CLIENT: CONEYGRE REDEVELOPMENTS LTD
 PROJECT: LAND OFF CONEYGREE ROAD TIPTON
 TITLE: AERIAL CGI

Scale: 1:50 @ A3	Date: AUG 2021
Design: DFC	Drawn: JC
Drw No: 19-103-PA-12	Revision: A

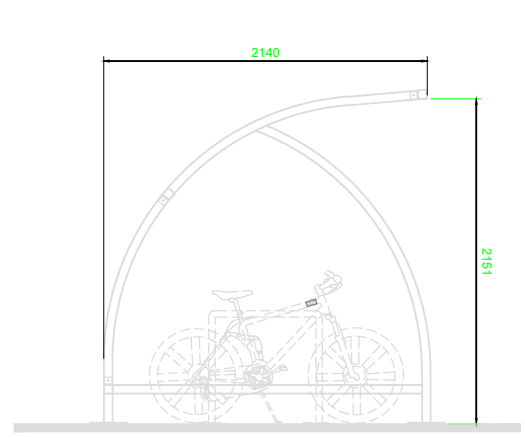

SIDE ELEVATION

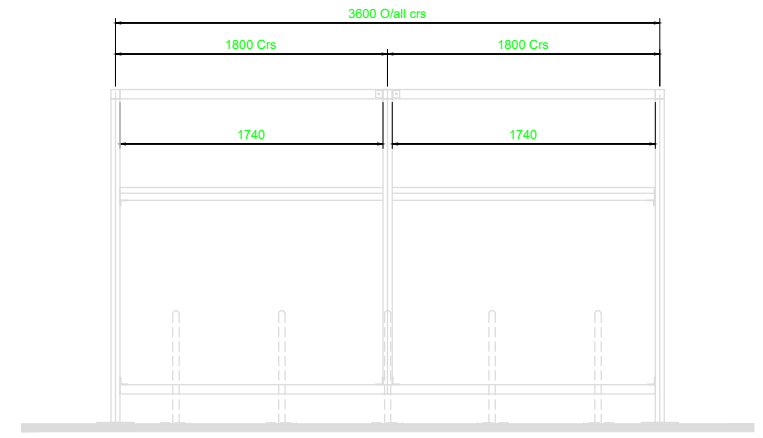

FRONT ELEVATION

CYCLE SHELTER SPECIFICATION.

50X50 SHS FRAME WITH 50X50 SHS PURLINS & TRIMMERS.
 WELDED END FRAMES AND PURLIN SECTION MADE FROM HEAVY-DUTY BOX SECTION ASSEMBLED WITH ANTI-TAMPER HIGH STRENGTH BOLTS.

ALL COMPONENTS TO BE GALVANISED WITH POLYESTER POWDER COAT FINISH

COLOUR BLACK WITH STANDARD CLEAR P.E.T SHEET ROOF PANELS.

CYCLE SHELTER TO BE BROXAP BXMW/SEF/36

EACH SHELTER TO ACCOMMODATE 8 No. CYCLES.

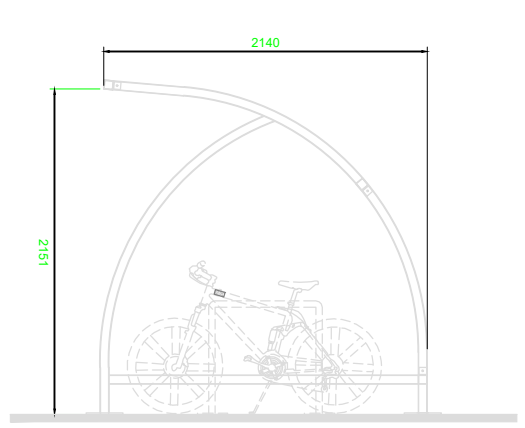

SIDE ELEVATION

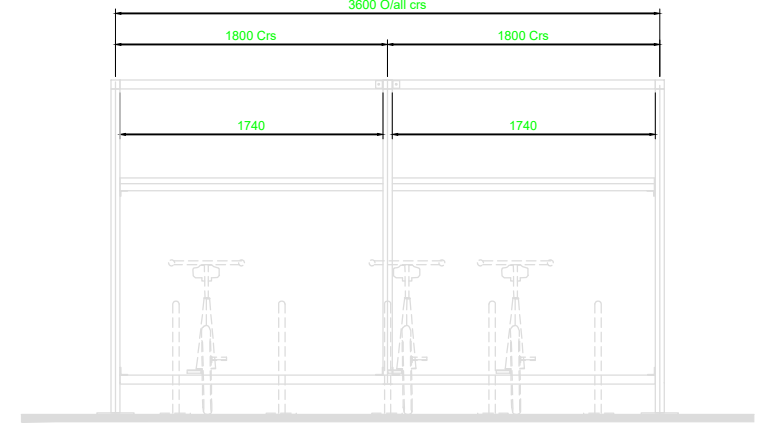

REAR ELEVATION

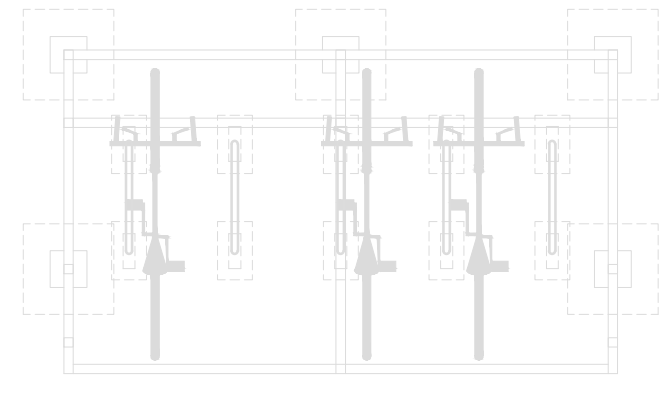

PLAN

PROPOSED CYCLE SHELTER DETAILS



ILLUSTRATIVE PERSPECTIVES

This drawing and the building works depicted are the copyright of BHP Design (UK) LTD. and may not be reproduced or amended except by written permission. No liability will be accepted for amendments made by other persons.

The Contractor is to check and verify all building and site dimensions, levels and sewer invert levels at connection points before work starts. The Contractor is to comply in all respects with current Building Legislation, British Standard Specifications, Building Regulations, Construction (Design & Management) Regulations, Party Wall Act, etc. whether or not specifically stated on this drawing. This drawing must be read with and checked against any structural, geotechnical or other specialist documentation provided.

This drawing is not intended to show details of foundations, ground conditions or ground contaminants. Each area of ground relied upon to support any structure depicted (including drainage) must be investigated by the Contractor. A suitable method of foundation should be provided allowing for existing ground conditions. Any suspect or fluid ground, contamination on or within the ground, should be further investigated by a suitable expert. Any earthwork constructions shown indicate typical slopes for guidance only & should be further investigated by a suitable expert.

Where existing trees are to be retained they should be subject to a full Arboricultural inspection for safety. All trees are to be planted so as to ensure they are a minimum of 5 metres from buildings and 2 metres from drainage and services. A suitable method of foundation is to be provided to accommodate the proposed tree planting.

Sketch proposals are for illustrative purposes only & as such are subject to detailed site investigation including ground conditions/contaminants, drainage, design & planning/conservation negotiations. Sketch proposals may be based upon enlargements of OS sheets & visual estimations of existing site features, accuracy will therefore need to be verified by survey. Sketch proposals have not been considered in respect of CON Regulations.

Notes:

Rev	Date	Note
A	23/09/21	Updated to suit LPA comments

PLANNING

Revisions: Amendment: Date: Name:

bhpdesign

St. Paul's Place, 40 St. Paul's Square, Birmingham, B3 1FQ, United Kingdom
 t. +44(0)121 314 6618 e : info@bhp-design.co.uk

CLIENT: CONEYGRE REDEVELOPMENTS LTD

PROJECT: LAND OFF CONEYGREE ROAD TIPTON

TITLE: TYPICAL CYCLE SHELTER DETAILS

Scale: 1:50 @ A3	Date: AUG 2021
Design: DFC	Drawn: JC
Drw No: 19-103-PA-12	Revision: A